

ASK 21 Mi



Flight Manual

Alexander Schleicher GmbH & Co. Segelflugzeugbau
36163 Poppenhausen - Germany

Flight Manual

for the powered sailplane

ASK 21 Mi

Model: ASK 21 Mi
Serial Number:
Registration letters:
TC Data Sheet No.: EASA.A.221
Issue: December 1, 2007

Pages identified by "App." are approved by the authority as shown below:

.....
Signature

.....
Aviation Authority

.....
Stamp

.....
Original Date of Approval

This powered sailplane is to operate only in compliance with the operating instructions and limitations contained herein.

The translation has been done by best knowledge and judgment. In any case the original text in German is authoritative.

Section 0

0.1 Record of Revisions

Any revision of the present manual, except updated weighing data, must be recorded in the following table, and in case of approved Sections endorsed by the European Aviation Safety Agency (EASA).

The new or amended text in the revised page will be indicated by a black vertical line in the left hand margin, and the Revision No. and the date will be shown on the bottom of the page.

Record of Revisions

Rev No.	Section & Pages Affected	Date of Issue	Approval	Date of Approval	Date of Insertion	Ref. / Signature

Issue: 01.12.2007 mh / mg / mm
Revision:

Record of Revisions

Rev No.	Section & Pages Affected	Date of Issue	Approval	Date of Approval	Date of Insertion	Ref. / Signature

Issue: 01.12.2007 mh / mg / mm
Revision:

0.2 Index of Effective Pages

Section	Page	Date	Section	Page	Date		
Title page	---	01.12.07					
0	0.1	01.12.07	App.	3.2	01.12.07		
	0.2	01.12.07	App.	3.3	01.12.07		
	0.3	01.12.07	App.	3.4	01.12.07		
	0.4	01.12.07	App.	3.5	01.12.07		
	0.5	01.12.07	App.	3.6	01.12.07		
	0.6	01.12.07	App.	3.7	01.12.07		
	0.7	01.12.07	App.	3.8	01.12.07		
	0.8	01.12.07	App.	3.9	01.12.07		
1	1.1	01.12.07	App.	3.10	01.12.07		
		01.12.07	App.	3.11	01.12.07		
		01.12.07	App.	3.12	01.12.07		
		01.12.07	App.	3.13	01.12.07		
		01.12.07					
2	App.	2.1	01.12.07	4	App.	4.1	01.12.07
		2.2	01.12.07		App.	4.2	01.12.07
		2.3	01.12.07		App.	4.3	01.12.07
		2.4	01.12.07		App.	4.4	01.12.07
		2.5	01.12.07		App.	4.5	01.12.07
		2.6	01.12.07		App.	4.6	01.12.07
		2.7	01.12.07		App.	4.7	01.12.07
		2.8	01.12.07		App.	4.8	01.12.07
		2.9	01.12.07		App.	4.9	01.12.07
		2.10	01.12.07		App.	4.10	01.12.07
		2.11	01.12.07		App.	4.11	01.12.07
		2.12	01.12.07		App.	4.12	01.12.07
		2.13	01.12.07		App.	4.13	01.12.07
		2.14	01.12.07		App.	4.14	01.12.07
3	App.	3.1	01.12.07	App.	4.15	01.12.07	
			App.	4.16	01.12.07		
			App.	4.17	01.12.07		
			App.	4.18	01.12.07		
			App.	4.19	01.12.07		
			App.	4.20	01.12.07		
			App.	4.21	01.12.07		

Section	Page	Date	Section	Page	Date
	App. 4.22	01.12.07		7.6	01.12.07
	App. 4.23	01.12.07		7.7	01.12.07
	App. 4.24	01.12.07		7.8	01.12.07
	App. 4.25	01.12.07		7.9	01.12.07
	App. 4.26	01.12.07		7.10	01.12.07
	App. 4.27	01.12.07		7.11	01.12.07
	App. 4.28	01.12.07		7.12	01.12.07
	App. 4.29	01.12.07		7.13	01.12.07
	App. 4.30	01.12.07		7.14	01.12.07
	App. 4.31	01.12.07		7.15	01.12.07
	App. 4.32	01.12.07		7.16	01.12.07
				7.17	01.12.07
				7.18	01.12.07
5	App. 5.1	01.12.07		7.19	01.12.07
	App. 5.2	01.12.07		7.20	01.12.07
	App. 5.3	01.12.07		7.21	01.12.07
	App. 5.4	01.12.07		7.22	01.12.07
	App. 5.5	01.12.07		7.23	01.12.07
	App. 5.6	01.12.07		7.24	01.12.07
	App. 5.7	01.12.07		7.25	01.12.07
	App. 5.8	01.12.07		7.26	01.12.07
	App. 5.9	01.12.07		7.27	01.12.07
	5.10	01.12.07		7.28	01.12.07
	5.11	01.12.07		7.29	01.12.07
	5.12	01.12.07		7.30	01.12.07
				7.31	01.12.07
				7.32	01.12.07
6	6.1	01.12.07		7.33	01.12.07
	6.2	01.12.07			
	6.3	01.12.07	8		
				8.1	01.12.07
				8.2	01.12.07
7	7.1	01.12.07		8.3	01.12.07
	7.2	01.12.07		8.4	01.12.07
	7.3	01.12.07		8.5	01.12.07
	7.4	01.12.07		8.6	01.12.07
	7.5	01.12.07		8.7	01.12.07

Section	Page	Date	Section	Page	Date
9	9.1	01.12.07			
	9.2	01.12.07			
	9.A.1	01.12.07			
	9.A.2	01.12.07			
	9.A.3	01.12.07			
	9.A.4	01.12.07			
	9.B.1	01.12.07			
	9.B.2	01.12.07			
	9.B.3	01.12.07			
	9.B.4	01.12.07			
	9.B.5	01.12.07			
	9.B.6	01.12.07			
	9.B.7	01.12.07			
	9.B.8	01.12.07			
	9.B.9	01.12.07			
	9.B.10	01.12.07			
	9.B.11	01.12.07			
	9.B.12	01.12.07			

0.3 Table of Contents

Section

- 0 Record of Revision, List of Effective Pages, Table of Contents
- 1 General
(Section without approval)
- 2 Operating Limitations and Data
(Approved Section)
- 3 Emergency Procedures
(Approved Section)
- 4 Normal Operating Procedures
(Approved Section)
- 5 Performance
(Section Partially approved)
- 6 Mass and Balance and C.G. Position
(Section without approval)
- 7 Description of the Powered Sailplane, its Systems, and
Equipment
(Section without approval)
- 8 Aircraft Handling, Care and Maintenance
(Section without approval)
- 9 Supplements
(Section without approval)

Section 1

- 1. General
 - 1.1 Introduction
 - 1.2 Type Certification Basis
 - 1.3 Special Annotations
 - 1.4 Description and Technical Data
 - 1.5 Three View Drawing

1.1 Introduction

This Flight Manual has been compiled in order to give pilots and instructors all the information they need for operating the ASK 21 Mi safely and appropriately.

The manual includes all data required to be available to the pilot as laid down in the Design Standards JAR-22, Amendment 6. In addition, we have provided a number of data and notes on operation which, our experience as manufacturers suggests, may be of use to the pilot.

1.2 Type Certification Basis

This powered sailplane of type designation ASK 21 Mi was type approved by the European Aviation Safety Agency (EASA) in compliance with Joint Airworthiness Requirements for Sailplanes and Powered Sailplanes JAR-22 issue March 15, 1982, amendment date Aug.1, 2001 (Amendment 6 of the English Original).

The Type Approval Certificate has been issued with No. EASA.A.221 under Airworthiness Category "U". U stands for Utility and refers to sailplanes and powered sailplanes used in normal gliding activities.

The noise emission measurements were carried out in accordance with ICAO, Annex 16, Volume I, Chapter 10 (corresponds the currently valid German requirements *Lärmschutzverordnung für Luftfahrzeuge [LVL]*, date Aug. 1, 2004, published in NfL II 70/04). The measurements established a noise level of 66.5 dB(A).

1.3 Special Annotations

Passages in this manual which are of special importance for flight safety or handling have been emphasized by being prefixed by one of the following annotations:-

- "Warning"** means that the non-observation of the corresponding procedure leads to an immediate or important degradation of the flight safety.
- "Caution "** means that the non-observation of the corresponding procedure leads to a minor or to a more or less long term degradation of the flight safety.
- "Note"** draws the attention on any special facts not directly related to safety, but which are important or unusual.

1.4 Description and Technical Data

The ASK 21 Mi is a shoulder wing glider with damped T-tail and sprung landing gear with hydraulic disc brake, and a nose wheel.

The wing is equipped with air brakes on the top surface.

The aircraft is built in FRP-sandwich-monocoque construction. The fuselage is partly reinforced with CFRP and SFRP.

The power-plant of this self-launching sailplane, with its electrically extendable propeller tower, is fitted in the fuselage behind the wing. Together with the rigid twin-bladed propeller the power-plant obtains a good performance and provides excellent rates of climb even at maximum all-up weight.

Technical Data

Span	17.00 m	55.74 ft
Length	8.35 m	27.38 ft
Height	1.55 m	5.08 ft
Wing area	17.95 m ²	192.95 ft ²
Aspect ratio	16.1	16.1
Max. take-off mass	705 kg	1554 lb
Max. wing loading	39.3 kg/m ²	8.05 lb./ft ²

1.5 Three View Drawing

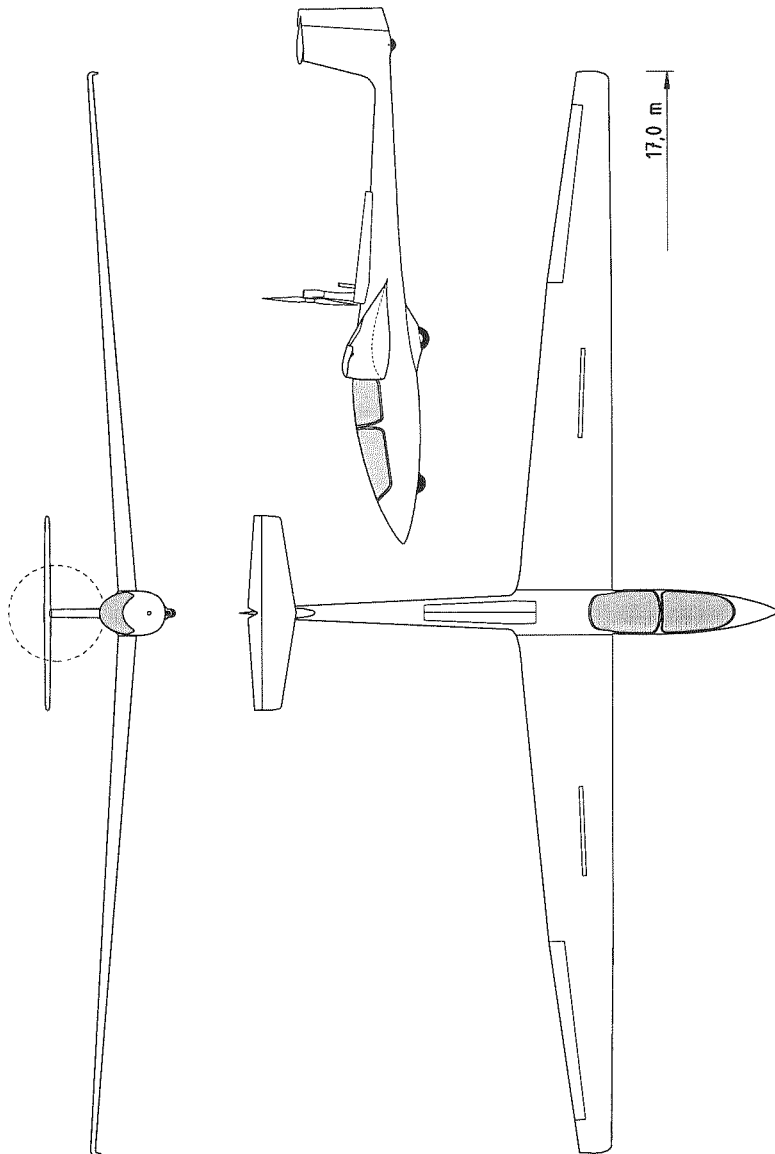

Section 2

- 2. Operating Limitations
 - 2.1 Introduction
 - 2.2 Air Speed
 - 2.3 ASI Markings
 - 2.4 Power-Plant
 - 2.5 Power Plant Control Unit Markings
 - 2.6 Masses (Weights)
 - 2.7 Center of Gravity
 - 2.8 Approved Maneuvers
 - 2.9 Maneuvering Load Factors
 - 2.10 Flight Crew
 - 2.11 Types of Operation
 - 2.12 Fuel and Oil
 - 2.13 Minimum Equipment
 - 2.14 Approved Launch Methods
 - 2.15 Limitations Placard

2.1 Introduction

This Section contains operating limitations, instrument markings and basic placards necessary for the safe operation of the powered sail-plane ASK 21 Mi, and its standard systems, installations, and standard equipment as provided by the manufacturer.

The operating limitations included in this Section and in Section 9 are approved by EASA.

2.2 Airspeed

Airspeed limitations (indicated airspeed IAS) and their operational significance are shown below.

	Speed	IAS	Remarks
V_{NE}	Never exceed speed for calm air	280 km/h 151 kts 174 mph	Do not exceed this speed in any operation and do not use more than 1/3 of control deflection.

For flights beyond 2000m (6500 ft) altitude V_{NE} must be reduced as prescribed in the placard included in Section 4.5.6.

This placard must be affixed next to the A.S. I.

V_{RA}	Maximum permissible speed for Rough Air	180 km/h 97 kts 112 mph	This speed must not be exceeded in strong turbulence. Examples of rough air are lee-wave rotors, thunderclouds, etc
----------	---	--	---

V_A	Maneuvering speed	180 km/h 97 kts 112 mph	Do not make full or abrupt control movement above this speed, because under certain conditions the aircraft structure may be overstressed by full control movement.
----------------------	-------------------	--	---

V_W	Maximum winch launching speed	150 km/h 81 kts 93 mph	Do not exceed this speed during winch or car launching
----------------------	-------------------------------	---------------------------------------	--

V_T	Maximum aero towing speed	180 km/h 97 kts 112 mph	Do not exceed this speed during aero towing.
----------------------	---------------------------	--	--

V_{PO} max	Maximum speed for extending and retracting the propeller	120 km/h 65 kts 75 mph	Do not extend nor retract the propeller outside of this speed range
V_{PO} min	Minimum speed for extending and retracting the propeller	90 km/h 49 kts 56 mph	
	Maximum speed with propeller extended	160 km/h 86 kts 99 mph	Do not exceed this speed with the propeller extended

2.3 Airspeed Indicator Markings

Airspeed indicator markings and their color-code significance are shown below.

Marking	IAS value or range	Significance
Green arc	88 – 180 km/h 48 – 97 kts 55 – 112 mph	Normal Operating Range
Yellow arc	180 – 280 km/h 97 – 151 kts 112 – 174 mph	Do not fly in this range with strong turbulence; and maneuvers must only be done with appropriate caution
Red line	280 km/h 151 kts 174 mph	Maximum speed for all operations.
Yellow triangle	98 km/h 53 kts 61 mph	Approach speed at maximum weight
Blue line	100 km/h 54 kts 62 mph	Best rate-of-climb speed[mg1]

2.4 Power-Plant

Engine manufacturer: Diamond Aircraft Ind.
Engine: IAE 50R-AA

Max. power:
- take-off 37.3 kW (3 minute limit) 7750 rpm
- continuous 35.8 kW 7100 rpm

Max. take-off revs: 7750 rpm
Max. continuous revs: 7100 rpm
Max. overspeed revs (20 sec.): 8000 rpm
Min. idle speed revs: 2800 rpm

Max. coolant temp., take-off: 90 °C (194°F)
Min. coolant temp., take-off: 40 °C (104°F)
Max. coolant temp., continuous: 100 °C (212°F)

Max. rotor cooling air temp., take-off (3 Min.): 120 °C (248°F)
Max. rotor cooling air temp., continuous: 110 °C (230°F)

Note: The above stated take-off performance refers to the minimum value as given in the engine data sheet. A nominal performance of 40 kW is typical on the other hand.

Lubricant: Total loss oil lubrication
at ratio: 1:60 approx.

Transmission: Toothed belt transmission with 1:2.68 reduction ratio.

The following types of propeller are approved:

Manufacturer: Alexander Schleicher GmbH
Propeller: AS2F1-1/R153-92-N1

2.5 Power-Plant Control Unit Markings

The following table shows the markings of the digital ILEC engine control unit and the meaning of the colors employed.

Green Diode Normal Operating Range 1800 to 7100	Yellow Diode Caution Range 7100 bis 7750	Red Diode with LCD blinking, impermissible range at 7750 plus
--	---	---

Permanent LC-Display:

RPM Indication (4 digits) [RPM]	Fuel Quantity (2-digits) [Liter]
XXXX	0 bis 23

Display reading when pressing the white button:

<i>Press 1 time:</i>	Liquid Coolant Temperature (3 digits) [°C]
H2O	XXX

<i>Press 2 times:</i>	Internal Cooling Air Temperature (3 digits) [°C]
Air	XXX

<i>Press 3 times:</i>	Current fuel consumption (4-digits) [Liter/h]
Fuel	XX.X

<i>Press 4 times:</i>	Engine Battery Voltage (4 digits) [Volt]
U	XX.X

2.6 Mass (Weight)

Max. Take-Off Mass::	705 kg (1554 lb)
Max. mass of all non-lifting parts:	510 kg (1124 lb)
Max. mass in baggage compartment (wing root):	each side 10 kg (22 lb)

2.7 Center of Gravity

The limits of the C.G. range are as follows:

forward limit	234 mm (9.22 in) aft of datum (BP)
aft limit	469 mm (18.47 in) aft of datum (BP)

"BP" (German: **Bezugspunkt**) stands in this context for "Reference Datum" which is identical with the wing leading edge at the wing root rib. One example of calculating C.G. positions is given in Section 6 of the ASK 21 Mi Maintenance Manual.

2.8 Approved Maneuvers

This powered sailplane is approved for normal sailplane and powered sailplane operation (Airworthiness Category "Utility").

Within the scope of this Airworthiness Category the following aerobatic maneuvers are approved – but only with the propeller tower retracted

- Spin
- Steep Climbing Turn
- Lazy Eight
- Loop upwards

2.9 Maneuvering Load Factors

Maximum maneuvering load factors:

max. positive load factor	+ 5.3
max. negative load factor	- 2.65
at an air speed of 180 km/h (97 kts)	

At increasing air speeds, these values will be reduced depending on the airbrakes setting to:

	retracted	extended
max. positive load factor	+ 4	+3.5
max. negative load factor	- 1.5	- 0
at an air speed of 280 km/h (151 kts).		

If a G-meter is installed, it must have the following markings:

Marking	Value or range	Significance
Yellow Arc	+4 – +5.3 -1.5 – -2.65	Caution Range
Red Line	5.3 -2.65	Must not be exceeded

2.10 Flight Crew

For solo flights the pilot must occupy the front seat.

With two up, the pilot in command occupies the front seat – unless the occupants agree prior to the flight that the pilot in command occupies the rear seat. This is only possible on the condition that all necessary operating elements and instruments are available in the rear seat and that the pilot is familiar with the operation of the aircraft from this position.

The minimum front seat payload is shown in the Operating Limitations Placard affixed in the front cockpit at the right wall (DATA and LOADING PLACARD).

One third of the weight of the rear pilot contributes to the payload in the front seat.

Lack of payload must be compensated by additional trim ballast weight. For this refer to the Mass and Balance Form in Section 6 and the description of trim ballast in Section 7.

2.11 Types of Operation

Flights may be carried out only in daylight, in accordance with VFR.

2.12 Fuel and Oil

Only fuel **WITHOUT** two-stroke oil must be refilled.

Capacity of the fuselage tank: 23.2 Liter 6.13 US Gal

Max. fuel quantity usable in flight: 23.0 Liter 6.08 US Gal

Non-usable fuel: 0.2 Liter 0.05 US Gal

Approved Octane Rating: minimum 95 ROZ

Approved fuel grade: **preferably AVGAS 100LL**
EUROSUPER, in compliance with
EN228, or equivalent quality

In the USA "US 95 Octane rating" complies with the minimum requirements prescribed by the engine manufacturer.

Maintenance Instruction "Fuel" must be regarded, it is included in the Annex of the Maintenance Manual. For further data refer also to the Engine Manual IAE50R-AA.

Engine oil:

preferably Silkolene Comp 2 Pre-mix (not Comp 2 Injector)

else: Bardahl KGR injection oil,
Castrol Aviation A545
Spectro Oils of America "Golden Spectro".

Oil tank capacity: 0.73 Liter 0.19 US Gal

Usable oil in flight: 0.70 Liter 0.18 US Gal

Non-usable oil: 0.03 Liter 0.01 US Gal

2.13 Minimum Equipment

Minimum Equipment consists of:

- 1 ASI indicating up to 300 km/h (162 kts), in each instrument panel
- 1 Altimeter, in each instrument panel
- 1 Magnetic Compass, in the front instrument panel
- 1 ILEC engine control unit, in each instrument panel
- 1 Rear view mirror
- 1 5-part seat harness (symmetrical), in each seat
- 1 parachute or back cushion (with about same thickness as a parachute, when compressed), for each pilot

For flights beyond the circuit of the airfield an aircraft radio is mandatory (for Germany). In addition, headphones should be worn when the engine is running.

Caution: When the engine is running, sufficient ear protection is strongly recommended!

For cloud flying the following instruments must be installed in addition:

- 1 Turn & slip indicator
- 1 Variometer

Approved equipment is listed in the Maintenance Manual in Section 12.1.

2.14 Approved Launch Methods

The maximum permissible launch speeds are:

for Aero tow	180 km/h	(97 kts)
for Winch Launch & Auto Launch	150 km/h	(81 kts)

For winch launch a weak link with a nominal strength of 1000 daN (2248 lbf) - black - must be used in the launch cable.

For aero tow a weak link must be used in accordance with the tug aircraft. It must not be stronger than nominal 850 daN (1911 lbf) - brown. The tow rope must be a textile rope of not less than 40 m (135 feet) and not more than 60 m (195 feet) in length.

The color of the weak links is not binding; this information refers to the color markings of the company Tost.

2.15 Operating Limitations Placard

This placard is fixed at the right cockpit side wall and contains the most important mass and speed limitations.

Segelflugzeugbau Alexander Schleicher GmbH & Co. Poppenhausen		Serial-No.: 21
Model: ASK 21 Mi		
DATA an LOADING PLACARD		
Empty Mass (Weight):	lbs	kg
Max. Mass (Weight):	1554 lbs	705 kg
Min. Front Seat Load Solo:	lbs	kg
Max. Front Seat Load:	lbs	kg
Max. Rear Seat Load:	lbs	kg
Max. Total Combined Seat Load	lbs	kg
Tire Pressure	Main Wheel:	3,4 to 3,6 bar
	Nose Wheel:	1,9 to 2,1 bar
	Tail Wheel:	2,4 to 2,6 bar
Maximum Permissible Speeds with retracted Power-Plant		
Calm Air:	151 kts 280 km/h	
Manoeuvring Speed:	97 kts 180 km/h	
Winch and Autotow Launch:	81 kts 150 km/h	
Aerotow A/T:	97 kts 180 km/h	
with Power-Plant installed		
To extend/retract Propeller:	min. 48 kts 90 km/h	
	max. 64 kts 120 km/h	
Propeller extended:	max. 86 kts 160 km/h	
Weak Link		
Winch Launch:	900 to 1100 daN (black)	
Aerotow:	max 900 daN (brown)	

For reduced minimum cockpit load in the front seat by fitting removable trim ballast in front of the pedals: see Section 7.11.

The baggage compartment load in the wing roots must not exceed 10 kg (22 lb) for each side.

Baggage compartment **max. 10kg**
22lbs

Section 3

- 3. Emergency Procedures
 - 3.1 Introduction
 - 3.2 Jettisoning Canopies
 - 3.3 Bailing Out
 - 3.4 Stall Recovery
 - 3.5 Spin Recovery
 - 3.6 Spiral Dive Recovery
 - 3.7 Engine Failure
 - 3.8 Fire
 - 3.9 Other Emergencies

3.1 Introduction

This Section contains Check Lists, summarizing procedures recommended in the case of emergencies, in the form of brief headings. This is followed by a more detailed description.

EMERGENCY PROCEDURES

(1)

To Jettison Canopies

- Ignition: **OFF!**
- Engage the propeller stop

front seat

- Move lever with red knob above the instrument panel to the left
- Push canopy upwards

rear seat

- Fully pull back both red canopy locking handles
- Push canopy upwards by the handles

(2)

Bailing Out**front seat**

- Push instrument panel upwards
- Open safety harness
- Get up
- Roll over cockpit side
- Push off strongly
- Watch wing & tailplane!
- Pull parachute

rear seat

- Open safety harness
- Get up
- Climb over cockpit side
- Push off strongly
- Watch wing & tailplane!
- Pull parachute

(3)

Spinning

- When power plant running: set throttle to IDLE
- Apply opposite rudder
- Short pause (1/2 spin turn)
- Relax back pressure on stick until rotation stops
- Centralize rudder and immediately pull out gently from dive.

(4)

Fire

- Fuel valve: **SHUT!** (aft position)
- Full throttle until engine stops
- Ignition: **OFF!**
- Retract the propeller if possible
- Power-plant main switch: **OFF!**
- Land as quickly as possible
- Extinguish fire

3.2 Jettisoning Canopies

If, during propeller-extended flight, jettisoning the canopy is unavoidable, the (running) propeller must at first be moved into a position which is less dangerous for the pilot. To do this switch off the ignition and engage the propeller stop. Do not wait until the propeller stops rotating but retract the propeller immediately. Any position from half-retracted on would seem sufficient. This position should prevent the canopy from being destroyed by the propeller and, thereby, pieces of the canopy from hurting the pilot.

After this procedure - or in the soaring configuration -:

- Front canopy: Move jettison lever (red knob above instrument panel) to the left and push canopy away upwards.
- Rear canopy: Pull back both red canopy locking handles and use them to open the canopy. The air stream will break off the canopy rearwards.

In a vertical dive, the air loads on the front canopy may be high. With some yaw, however, low pressure builds up over the canopy. Therefore, apply some rudder in this case!

3.3 Bailing Out

If bailing out becomes inevitable, first the canopy is jettisoned, and only then should the seat harness be released.

Front Pilot: Push instrument panel upwards (if this was not yet already done in the course of jettisoning the canopy). Get up or simply roll over cockpit side.

Rear Pilot: Get up - the supporting structure at either side of the instrument panel and the canopy arch serve as handholds - and climb out.

When jumping, push yourself away from the aircraft as strongly as possible.

Watch wing leading edge and tailplane!

3.4 Stall Recovery

In straight or circling flight, relaxing of back pressure on the stick will always lead to recovery. Due to its aerodynamic qualities the ASK 21 Mi will immediately re-gain flying speed.

3.5 Spin Recovery

According to the standard procedure spinning is terminated as follows:

1. When the **engine** is running: set throttle to '**IDLE**'.
2. Apply opposite rudder (i.e.: in the direction opposite to the rotation of the spin)
3. Short pause (hold control inputs for about ½ spin turn).

Warning: If you ignore the pause, it may delay the recovery!

4. Release stick (i.e. give in to the pressure of the stick) until the rotation stops and sound airflow is established again.

Warning: Full forward stick may retard or even prevent the recovery!

5. Centralize rudder and gently pull out of the dive.

The altitude loss from the beginning of the recovery until the normal flight attitude is regained is about 70 to 100 meter (230 to 330 feet).

Note: During spins the ASK 21 Mi oscillates in pitch. From a steep nose down spin recovery according to the standard procedure is up to 1 turn, from a flat slow spin less than 1 turn.

Caution: With the propeller extended the engine must only be in 'Idle Position'! This makes sure that the engine will not over-rev when pulling out of the spin.

3.6 Spiral Dive Recovery

Depending on the aileron deflection during spin with forward C.G. positions, i.e. in the range where the ASK 21 Mi does no longer sustain a stationary spin, the aircraft will enter immediately or after only a few turns a spiral dive or a slipping turn similar to a spiral dive. Both flight attitudes are terminated as follows:

- Opposite rudder
- Aileron against the direction of rotation of the spin.

3.7 Engine Failure

(1) Failure at Safe Altitude

- Fuel Valve: **OPEN?** (foremost position?)
- Ignition: **ON?** (upward position?)
- Main Switch: **ON?** (ILEC responding?)
- Fuel pump 2: **ON?**
- Fuel: **???** (Fuselage tank contents?)
- ILEC Change Over Switch: **Turned towards the pilot?**

If the above points check out correctly, the fault cannot be rectified in flight, the propeller should be retracted and the ASK 21 Mi should from then on be operated as a pure sailplane. Retract propeller in the normal manner in accordance with the check list.
If necessary, carry out a normal sailplane outlanding.

(2) Failure at Low Altitude

First check the points on the above check list.

- Fuel Valve: **SHUT!** (rearmost position)
- Ignition: **OFF!**
- Main Switch: **OFF!**
- Propeller Stop: **ENGAGED!** (bottom position)
- Leave the propeller extended
- Initiate outlanding

If the situation becomes so critical that a crash landing seems unavoidable because no landable terrain can be reached, the propeller stop should be engaged at a speed of about 90 km/h (49 kts) - even with the propeller still running. This will help to stop the propeller more quickly. Then retract the propeller at least to a "halfway in" position.

This action not only improves the gliding performance (perhaps now a more suitable field can be reached), but also reduces the risks in case of a crash landing. In this case the main switch must not be turned off until the propeller has reached at least its partially retracted position.

(3) Strong Buffeting of the Power-plant

Proceed as per check list. If no mistake can be found, shut off the power-plant in the normal manner and retract the propeller. The pilot must assume that the propeller is damaged and hence may be out of balance. Do not start the engine any more.

3.8 Fire

(1) Fire with propeller extended

A fire in the engine compartment is indicated by a red blinking diode in the instrument panel. Further details are given in Section 7.7. Monitor as per Check List 3.1 (4) and land as quickly as possible. If possible, retract the propeller, as closing the engine doors will reduce the oxygen feed! Smother fire with extinguisher or fire blanket (clothing).

(2) Fire with propeller retracted

The propeller remains retracted because of the reduction of oxygen supply.

- Fuel Valve: **SHUT!**
- Power-Plant Main Switch: **OFF!**
- Land as quickly as possible
- Extinguish fire

3.9 Other Emergencies

(1) Groundloops

If the aircraft threatens to roll out beyond the intended landing area, the decision should be made not less than 40 m (140 ft) before reaching the end of the landing area to initiate a controlled ground loop.

- If possible, turn into wind!
- When putting down the wing, at the same time push the stick forward and apply opposite rudder!

(2) Strong Noise Development Due To Defective Exhaust Silencer

If the noise from the exhaust silencer is considerably increasing, a failure of the exhaust system must be taken into account. Because hot exhaust fumes may cause fire, the engine must be stopped immediately or after reaching a safe height respectively. Prior to the next flight the exhaust system must be inspected and if necessary repaired.

(3) Throttle Cable Broken

If the throttle cable fails, a spring at the throttle valve housing opens the throttle valve wide open and the engine is running a full throttle. Climb to a safe height, switch off the ignition, let the propeller run down so that it can be retracted in the normal manner.

If no airfield or landable terrain is nearby and further height gain is no more possible, you may prevent a further climb by using the airbrakes. Then you may continue the flight in this configuration until you can reach an airfield. Prior to landing switch off the ignition and retract the propeller.

(4) Defective Airbrake Control Circuit

If sudden strong change of flight course happens, the pilot should immediately visually check that the airbrakes have extended on both wings as this asymmetry may be caused by an airbrake extended on one wing only. This problem could occur after a defect in the airbrake control circuit and cannot be compensated by rudder deflection. If the airbrake has extended on one wing only, the other airbrake must immediately be extended so far that the aircraft will regain level flight and the airbrake lever must be hold in this position.

Depending on the flight height immediately initiate an outlanding.

Section 4

- 4. Normal Operating Procedures
 - 4.1 Introduction
 - 4.2 Rigging and De-rigging
 - 4.3 Daily Inspection
 - 4.4 Pre-Flight Checks
 - 4.5 Normal Operation and Recommended Speeds
 - 4.5.1 Operating the Power-Plant
 - 4.5.2 Winch Launch
 - 4.5.3 Aero tow
 - 4.5.4 Free Flight
 - 4.5.5 Landing Approach and Landing
 - 4.5.6 High Altitude Flights
 - 4.5.7 Flight in Rain
 - 4.5.8 Cloud Flying
 - 4.5.9 Aerobatics

4.1 Introduction

This Section contains Check Lists for the daily inspection and pre-flight checks. It also describes normal operating procedures. Normal operation procedures associated with the aircraft, if equipped with various ancillary systems and equipment not included as standard equipment, are described in Section 9.

4.2 Rigging and De-rigging

The aircraft can be rigged without use of rigging aids by four people, or by three people if a fuselage cradle and wing trestle is used.

Prior to rigging all pins, bushings and control connections must be cleaned and lubricated.

1. Support fuselage and keep upright.
2. Insert left wing spar fork into fuselage and support its outer end with a trestle, if available.
3. Insert right wing spar root.
4. Press in the two main pins and secure them with the safety hooks at the spar tunnel. Never insert the rear wing attachment pins prior to the main pins!
5. Press in the rear wing attachment pins; unscrew the T-tool and check whether the safety lock is engaged.
6. Connect the aileron control linkages behind the spar tunnel. You must be able to touch the ball pivot by feeling through the slot in the socket. Also check the proper engagement of the safety lock by pushing it on to close!
7. Connect the airbrake control linkages behind the spar tunnel.

All quick-release connectors must be secured by safety elements against unintentional release. Mainly the so-called Wedekind safety sleeves are used.

During assembly of the quick-release connectors either the aluminum safety sleeve is pushed back until the wedge may be pushed in entirely, or the spring is removed from the check hole of the wedge. After the careful assembly of the quick-release connectors check that the spring-loaded safety sleeve secures the wedge again completely.

All quick-release connectors must be tested by pulling the push-rods - socket ends off the ball heads -, applying a force of not less than 5 daN (10 lb), and it must be checked that the safety elements are in their correct position.

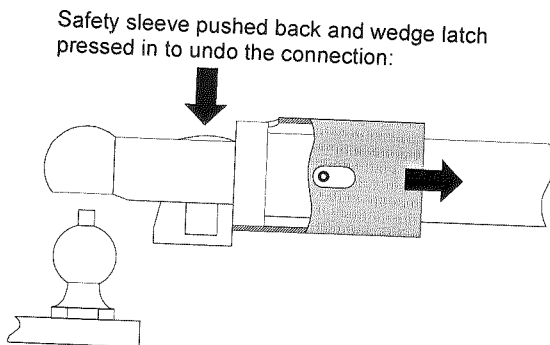
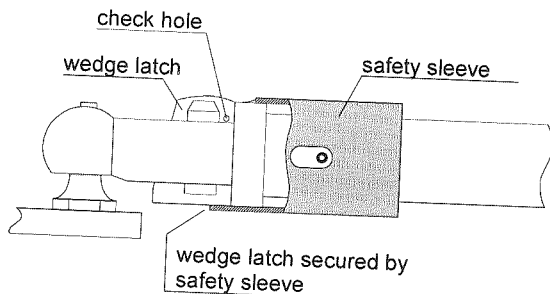

8. The tailplane is pushed on to the fin from the front and the elevator must be guided into the elevator connection. Now push the tailplane home until the hexagon socket head bolt (Allen screw) at the leading edge will engage its thread. The bolt must be fully and firmly tightened. The spring loaded lock must engage correctly.
9. Carry out a pre-flight check referring to the Check List.
10. The control circuits must be tested for proper operation.
11. Check condition and function of the wheel brake; check the tire pressure. See also Section 4.3 "Daily Inspections".
12. A considerable performance improvement can be achieved with little effort by taping all gaps between wing junctions with plastic self-adhesive tape (on the non moving parts only). Also the fin-tailplane junction should be taped up.

Warning: The fuselage access hole cover must be taped up, to ensure that it does not get lost in flight, even if it has not been properly locked. This would cause damage to the propeller, when the engine is running.

The canopy rim must not be taped over, so as not to impair bail-out.

It is recommended that areas to be taped up should be thoroughly waxed beforehand, so that afterwards the adhesive tape can be removed cleanly without lifting off the paint finish.

De-rigging

De-rigging is carried out in the reverse sequence of rigging. It must be taken care that the rear wing attachment pins have to be removed prior to the main pins.

Warning:

To de-rig the horizontal tail from the fin, only use the method according to Fig. 4.2-1.

Fig. 4.2-1

WRONG: Twist Movement

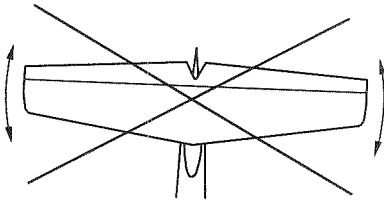

RIGHT: Pitch Movement

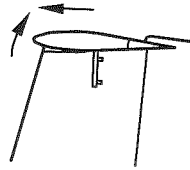

4.3 Daily Inspection

- 1) Open canopies. Check that the main pins are properly secured by the safety hooks!
- 2) Check control connections of ailerons and air brakes in the fuselage through the access hole at the left side above the wing. Are the safety elements used /engaged on the quick-release connectors? Finally the access hole cover must be taped up!
- 3) Check cockpit and control runs for loose objects.
- 4) Check condition and operation of tow release couplings. No soiling? Actuate the tow release: does it snap back freely? Engage and disengage the ring pair. Check the automatic release of the C.G. towing hook with the ring pair which must release automatically backwards.
- 5) Free movement of all controls? Check the plastic tubes inside the S-shaped tubes of the rudder pedals for correct and tight fit.
- 6) Check wheel brake. Pull the air brakes lever: with airbrake paddles fully extended the resilient brake pressure from the main brake (master) cylinder should be felt through the brake handle.
- 7) If your aircraft is fitted with a steerable nose wheel (optional), check its operation!
- 8) Check condition of Pitot tube in the fuselage nose!
- 9) Check tire pressure in the wheels!
- 10) Check the whole fuselage for damages, in particular the bottom side!
- 11) Check both upper and lower surfaces of the wing for damage.
- 12) Aileron: condition, free movement, and play must be checked! Also the push rod connections.

- 13) Air brake: check condition, free movement, alignment and locking.
- 14) Rear wing attachment pins pressed in and secured?
- 15) Check that static ports in the fuselage tail boom are unobstructed!
- 16) Check the condition of the Pitot tube and the Total Energy probe respectively! Are they firmly seated?
- 17) Rudder: check condition, free movement, and play!
Cable connections secured?
- 18) Check tailplane for correct assembly, and for correct engagement.
Elevator and actuator: condition, free movement, and play!
- 19) Check control linkages of elevator, aileron, rudder and air brakes for free movement and for force-fit. Hold controls firmly at full deflection while loads are applied to stick, pedals and air brakes lever respectively.

After rough landings or excessive flight stress the whole aircraft must be checked with the wings and tail unit removed. If any damage is found, a technical inspector must be called in. On no account one must take off again before the damage has been repaired.

Fig. 4.3-1 Tour around the aircraft (see Daily Inspection 4.3)

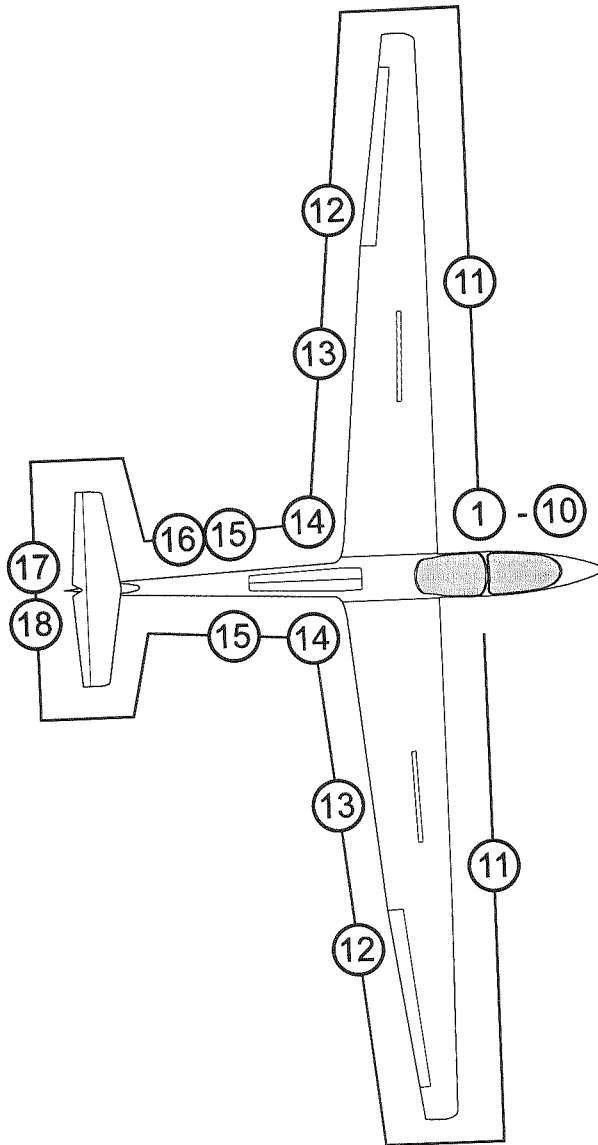

Daily Inspection with Extended Propeller

- a) When extending the propeller pay attention to unusual noise and stiffness of operation.
- b) The most important bolted connections can be checked from above through the open engine bay doors. With one exception they are secured with standard stop nuts, and therefore are easy to check. Particular attention must be paid to both front engine mounting screws and to the bolted connections of the extending toggle crank with jack head.
- c) The rear engine mounting screw which is running through the engine oil tank is secured with locking wire. Check this locking wire for damage.
- d) By pushing against the propeller assembly from the side and from the front, check the rubber elements of the engine mounting. The power-plant should react flexible and should not immediately move against the fuselage structure.
- e) Check the toggle over dead center of the drive mechanism of the propeller assembly! Do both sides have good over-center lock?
- f) Inspect the mounting of the exhaust silencer. The spring mountings can be checked by shaking the silencer.
- g) Check mounting of radiator, and the radiator support plate for incipient cracks.
- h) Check operation of throttle and propeller stop mechanism.
- i) Any kinks in Bowden cables or fuel lines and hoses? Elastic cords of the engine bay doors in good condition?
- j) Inspect lines (especially fuel lines and coolant hoses) and all components for signs of chafing.
- k) Check mounting of the flexible ram pipe. Is the air filter at its upper end securely seated?

l) Check limit switch for electric jack for damage and secure seating - including the electrical connections.

m) Check the toothed belt for wear and correct pre-tension.

It should be possible to twist the belt just by 30° with normal hand force applied between the bottom belt pulley and one of the guide pulleys. This measuring method may be relatively imprecise, yet it may aid to recognise a considerably too low belt tension. Further notes on measuring and adjustment of belt tension are given in the Maintenance Manual, Section 2.

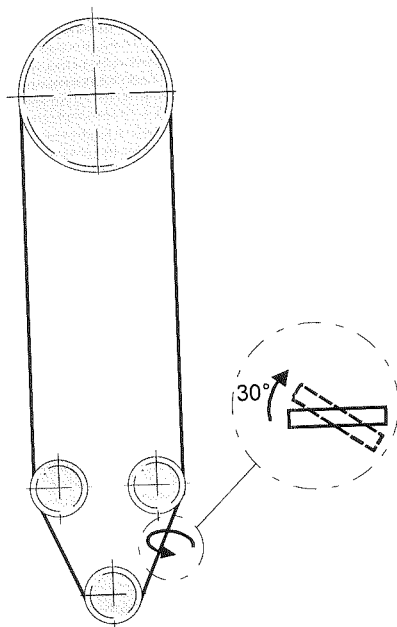

n) Turn the propeller through by hand one time (Ignition OFF?) and check for excessive friction, unusual noise and compression.

Visual Inspection of the Propeller

- Visual inspection of the propeller as per propeller manual.
- Visual inspection of propeller mounting.

Tank System (fuel and oil)

- a) Fuel tank cap correctly closed?
- b) Check visually fuselage tank for leaks.
- c) Press drainer and release any condensation if present. Watch carefully that the drainer afterwards closes again tightly. The drainer is situated at the fuselage bottom left side below the wing.
- d) Check fuel tank vent opening. This vent is fitted next to the drainer.
- e) Check fuel contents for a safe take-off (min. 5 liters!).
- f) Check engine oil tank (between engine and exhaust silencer) for signs of leakage. Level check! Sufficient oil usage? (See also Section 7.8)

Always top up the oil tank to approx. 1 cm (0.39 in) below the filling hole.

4.4 Pre-Flight Checks

The following Check Lists containing the most important points are affixed within easy view of the front seat pilot:

Pre Flight Check

1. Main pins secured ?
2. Check control connection !
Quick-release connectors secured ?
3. Check cockpit for foreign objects !
4. Check tow release hooks ! Release test !
5. Check controls for positive connections,
free movement and permissible play !
6. Check pitot tube in the nose !
7. Tire pressure checked ?
8. Any visual damage to fuselage, wing and tail ?
9. Rear wing attachment pins secured ?
10. Static pressure ports dry and unobstructed ?
11. Check TE probe, firmly seated ?
12. Check elevator and rudder !
13. Observe mass and balance data, CG position !
14. Check fuel contents ?
15. Engine checked as per the manual ?

Pre Take-off Check:

1. Tail dolly removed ?
2. Parachute fastened correctly ?
3. Automatic parachute rip-chord connected ?
4. Safety harness tight (particularly lap belt) ?
5. Controls easy to operate ?
6. Airbrakes retracted and locked ?
7. Trim set in take-off position ?
8. Altimeter adjusted ?
9. Radio operational and transmission tested ?
10. Check wind direction !
11. Both canopies closed and locked ?
12. Action for aborted take-off in mind ?

Caution:

Prior to solo flights the pilot must satisfy himself that both the switch of the fuel pump 2 and the ignition switch of the rear ILEC-control unit are „OFF“!

4.5 Normal Operation and Recommended Speeds

4.5.1 Power-Plant Control and Self-Launch

Warning: Access hole cover correctly locked and taped up? Non-observance risks that it may become loose and damage the propeller when the engine is running.

Checklist, extending propeller and starting engine

- Fuel valve: **OPEN**
- Power-plant main switch: **ON** (ILEC responding)
- With the ILEC change-over switch select the master unit
- Switch "Extend Propeller" engaged upwards?
- Green LED "Propeller extended" on?
- Propeller stop disengaged?
- Ignition: **ON**
- Fuel pump 2: **OFF**
- Check fuel pump 1 (must be heard)!
- Fuel pressure okay? LED „FUEL“ **OFF**?
- Is the ECU-light constantly **RED** or is it flashing?

Cold and warm start on the ground (not too cold)

- Propeller CLEAR?
- Throttle: IDLE (lowermost setting)
- Press STARTER button max. 5 seconds
- If engine does not fire, press STARTER again, after a short rest period for the starter battery
- Select throttle setting until the engine is running smoothly
- Is the ECU-light off or is it constantly red?
- Allow engine to warm through at **4000 RPM** for 2 minutes (or up to a coolant temperature of 40 °C)
- Check ignition circuits at **6200 RPM**. Maximum RPM drop 300 RPM.

Cold start (very cold, engine heavily cooled down)

- Propeller CLEAR?
- Throttle: IDLE (lowermost setting)
- Press STARTER button max. 5 seconds
- If engine does not fire, press STARTER again after a short rest period for the starter battery
- Select throttle setting until the engine is running smoothly
- Is the red ECU-light off or is it constantly on?
- Allow engine to warm through at **4000 RPM** for 3 to 4 minutes (or up to a coolant temperature of 40 °C)
- Check ignition circuits at **6200 RPM**. Maximum RPM drop 300 RPM.

Cold and warm start in flight

- Air speed 90 to 110 km/h (49 – 60 kts, 56 – 68 mph)
- Throttle: IDLE (lowermost setting)
- Press STARTER
- Is the red ECU-light off or is it constantly on?
- If possible, allow engine to warm through
- Reduce airspeed and move throttle to Wide Open (watch rate of revolutions!)

Checklist stopping engine and retracting propeller

- Air Speed: 90 – 100 km/h (49 – 54 kts, 56 – 62 mph)
- Throttle: IDLE (lowermost setting). Wait until low RPM have stabilized
- Ignition: **OFF**
- Let engine revs. die down
- Engage propeller stop lever (bottom position). When engaging the stop the propeller must not stand direct above the stop block
- Wait until propeller runs against the propeller stop block
- Check vertical position of the propeller by means of the mirror
- Hold down switch "Retract" and let propeller retract only so far that its tip can no longer be seen in the rear view mirror.

Note: While the "Retract" switch is pressed the retraction process is automatically interrupted after 2/3 of the travel (cooling position). A short signal is audible when this position is reached. The pilot must press the switch again, if he wants the entire retraction at this point.

After about 2 minutes or when the maximum liquid coolant temperature has dropped by at least 2°C, press again "Retract" until the ILEC LED "Propeller retracted" lights.

- Switch off Power-Plant Main Switch by pressing the red key next to it.

Revolution Rates (RPM) and Speeds

- Best climb: at $v_y = 100$ km/h (54 kts, 62 mph blue line).
 Cruising speed: 130 to 140 km/h (70 – 75 kts, 81 – 87 mph) at 7100 rpm.
 Maximum take-off revs: 7750 rpm (3 minute limit)
 Maximum continuous revs: 7100 rpm.

The power-plant of the ASK 21 Mi gives the possibility to self-launch with good climbing performance, extending the operational range of a pure sailplane. It is advisable to familiarize oneself with the extending and starting procedures in the first instance within safe reach of an air-

field, before attempting a cross country flight. The power-plant of a powered sailplane must not be regarded as a life insurance, for instance when crossing unlandable areas. One should always be prepared for the possibility that the power-plant will fail to deliver the hoped-for propulsion. This may not necessarily be due to a technical shortcoming, but might be caused by nervous tension of the pilot (mistakes in carrying out starting procedure). The engine and its reliability should be regarded in the same light of a sailplane pilot's experience, that a thermal is not necessarily found when it is most urgently needed.

The engines of powered sailplanes are not subject to such stringent production and test regulations as normal aviation engines, and therefore cannot be expected to be quite so reliable.

A minimum safe height for extending the propeller and starting the engine must be met. The criterion is that it must be possible to retract the propeller again and carry out a normal sailplane outlanding if the engine cannot be started. A general valid value for this minimum safe height is about 300 meters (980 feet); however, this is depending also strongly on pilot ability and geographic factors.

(1) Extending the propeller

Proceed as per checklist.

If the red ECU light goes off after switch-on of the ignition and then starts flashing after about 10 seconds, a defect must be suspected in some area of the electronic engine circuit. Such defect must be repaired prior to the next take-off. Further details on the flash error code are given in Section 7.7 in this Flight Manual or in the Engine Manual.

If - after the ignition is switched on - the red FUEL alarm light is still on, the fuel pressure is insufficient to get a flawless function of the injection system and to reach full engine output. Reason may be a fault with the fuel pumps or the pressure regulator, else possibly a leak in the fuel system.

Warning: In such a case the engine must be shut off immediately. No self-launch is allowed.

If the defect occurs during take-off phase in powered flight, the necessary fuel pressure may possibly be reached by switching on the fuel pump 2. After reaching safety height the engine must be shut off immediately and the pilot must land without delay. The defect must be repaired prior to the next take-off.

Do not extend the propeller at increased g-loads. For instance while circling g-loads can increase to such an extent that the electric jack extends the propeller only very slowly, or fails to do so fully. Speed range for extending and retracting the propeller is given in Section 2.

(2) Starting the Engine

Warning: For a test run of the power-plant the wings **must** be rigged **and** the aircraft must be safely chocked! For a test run a competent person must sit in the cockpit.

Caution: The local conditions for a safe take-off should be checked prior to take-off in accordance with the data given in Section 5 of this manual.

Proceed as per checklist.

If the engine fails to start, check it over as recommended in the Engine Manual. It makes no sense to press the STARTER button for more than 5 seconds because this will unnecessarily stress the battery. The fuel injection system will normally provide a smooth starting of the engine. If problems occur, an operating error should be considered. A closed fuel valve already prevents the starting of the engine.

With the engine running the red ECU light normally is off. If it remains constantly on when the engine is running, a defect must be suspected in some area of the electronic engine control system. Such defect must be repaired prior to the next take-off. If the light turns on during flight, the flight may be continued provided that the engine is running normally. As the measuring sensors are partially double-existent, an error prompt will not necessarily take a direct effect on the engine performance. Yet if such error prompt occurs, all indicating elements should be constantly monitored to verify they meet the permissible values.

Note: Prior to the next take-off such defects must be repaired.

Allow engine to warm through on ground at 4000 RPM for 2 to 4 minutes (depending on ambient temperature) until the coolant temperature indicates around 40 °C (104°F). This way it will be ensured that the engine will smoothly accelerate to max. RPM.

If the operating temperature is still too low (interior cooling air) the electronic injection system will adjust the RPM down. Only if the ground-test RPM has reached at least 7000 RPM and the engine is running smoothly, a safe self-launch can be carried out.

Note: Depending on the wind speed lower ground test RPM will be reached in a downwind while a head-wind will increase the ground test RPM.

With temperatures below -10 °C (14 °F) the engine should not be started because there is the danger with a very cold engine that the lubricant oil is too thick and thus the oil feed into the engine could be interrupted.

(3) Self-Launch

- ECU light
- as a precaution fuel pump 2
- after reaching safety height: fuel pump 2
- after 3 minutes max. take-off RPM: reduce to

OFF ?
ON
OFF
7100 RPM

For a safe self-launch maximum engine revolutions should come up to 7000 RPM on the ground. With lower revolutions the pilot must face longer take-off distances than indicated in Section 5.2.3.

Warning: If maximum revolutions on the ground are below 7000 RPM, the aircraft must not take off. First a check must be done and a ground-test run. In case of doubt contact the manufacturer.

Warning: For the following reason it is prohibitive to switch over between the two ILEC control units during powered flight: If the ignition is set „OFF“ at the control unit to which the pilot wants to change, then the engine fails, as the ignition power supply switches off during change over.

For the acceleration run and actual lift-off, the following practices apply: Trim and elevator neutral. Take-off run first on both nose wheel and main wheel. When sufficient speed is gained continue on the main wheel and gently pull the stick until the aircraft lifts off.

(4) Climbing Flight

During climbing flight, the engine should be run at maximum 7750 rpm and at v_Y . Pay attention that this take-off power is only allowed during the 3 minute limit.

(5) Cruising Flight

This can be carried out either in a saw-tooth pattern (climb followed by straight glide with propeller retracted), or in horizontal flight at 7100 rpm and an air speed of 125 km/h (67.5 kts, 78 mph). Monitor fuel state.

Caution: Prior to flight check that the oil supply is sufficient for the whole intended fuel contents. Monitor oil warning light during powered flight!

A detailed description of the ILEC engine control unit is given under Section 7.7.

(6) Stopping the Power-Plant

Caution: To prevent damage to the propeller, the procedures described hereafter must be met!

With normal outside air and engine temperatures the flight testing has shown that there is no need for a longer cooling run. Only with very high engine and outside air temperatures it is actually necessary to do a longer cooling run of 1 to 2 minutes which must then be done in fast level flight. To do this the engine revs must be adjusted between 6400 and 6600 rpm at a speed of about 130 km/h (70 kts, 81 mph). Contrary to a cooling run with the engine idling, the cooling water pump and cooling air fan still operate efficiently at these RPMs; as the throttle setting of about 50 % results in less combustion heat inside the engine, while there is still a good heat transport to the outside.

A longer cooling flight at lower flight speeds and with the engine **idling** must **not** be done, because then the exhaust heats up strongly (the Venturi at the exhaust pipe does no longer supply sufficient cooling air through the outside fairing of the exhaust).

The higher temperature of the exhaust silencer does not mean a problem per se for the structure of the fuselage, but if after this cooling run the propeller is at once completely retracted without further waiting time, the hot air from the exhaust silencer may damage the propeller and reduce its service life.

(7) Retracting the Propeller

Only after the engine RPM have almost completely died down and the propeller is only yet wind-milling the propeller stop block must be swiveled into the arc of the propeller. Max. speed for this is 120 km/h (65 kts, 74mph).

The progressive retraction of the propeller is indispensable to save the propeller. This procedure serves to better cool down the power-plant and the exhaust silencer. Particularly with high outside air temperatures the pilot must not do without this.

Note: While the RETRACT switch is pressed down, the retraction of the propeller is automatically interrupted after 2/3 of the travel (cooling position). A short signal is audible when this position is reached. The pilot must press the RETRACT switch again in order to retract the propeller entirely.

In practical operation the following procedure has proven good:

After engine shut-off the *water* temperature first increases a little, because the coolant is no longer circulated. The temperature sensor is fitted direct at the engine housing and soon shows the temperature of the housing. Thus, the water temperature indicates the degree of cooling-down. Monitor this temperature and wait until the maximum value has dropped by about 2 °C. Only then the propeller may be completely retracted without any problems.

When the ignition is off, the ECU is no longer active and so the cooling *air* temperature is no longer indicated because the ECU is providing this value to the ILEC engine control unit.

Note: During cooling position of the propeller the red LED at the ILEC "Propeller not fully retracted" is flashing as a reminder that the retraction process has not yet been terminated.

4.5.2 Winch Launch

- Winch launch only at the C.G. tow release coupling in front of the main wheel
- Trim set at about 1 cm aft off forward position
- Max. tow speed 150 km/h (81 kts, 93mph)
- Favourable tow speed 100 to 120 km/h (54 – 65 kts, 62 – 74 mph).

There is little pitch up tendency during the initial tow.

Tow release: pull the release knob to the stop several times

Caution: Before Take-Off, check seating position and that controls are within reach. The seating position, especially when using cushions, must preclude the possibility of sliding backwards during initial acceleration or steep climb.

Warning: We expressly warn against attempting any launch by an under-powered winch in a tail wind!

Caution: In case of tow rope break immediately push stick and watch stabilized flight attitude (A.S.I) prior to further action!

4.5.3 Aero Tow

- Aero tow only at the nose tow release coupling in front of the nose wheel.
- Recommended tow rope length: 40 m to 60 m (135 ft to 197 ft); textile rope.
- Trim set to center position.
- Max. tow speed 180 km/h (97 kts, 112 mph).
- Favorable tow speed in climb flight: 100 to 140 km/h (54 – 76 kts, 62 – 87 mph).

Take-off run can be started with the wing tip on the ground. Getting the wings level is no problem. However, the pilot is advised to be careful with high grass and very rough ground.

Maximum acceptable cross wind component is 20 km/h (10.8 kts).

4.5.4 Free Flight

The aircraft may be flown up to $V_{NE} = 280$ km/h (151 kts, 174 mph), see also Section 2.2. Up to maneuvering speed of 180 km/h (97 kts, 112 mph) full control deflections can be applied. At higher speeds the controls must be applied more carefully. At V_{NE} only 1/3 of the max. possible deflections must be applied.

Low speed flight and stalling behaviour:

With the stick back a distinct tail buffet is felt. The aircraft is very benign in low speed flight. By use of normal aileron deflections the wing may be kept level down to minimum speed, even with aft C. of G. positions. With normal rudder deflections no wing dropping is found. Yaw angles of up to 5° have no significant influence on the wing dropping attitude.

Also rapid pulling up into 30° pitch does not cause wing dropping, but just a gentle nose drop.

The same applies for stalling out of a 45° turn. But one has to point out that even the most benign aircraft needs speed in order to be controllable. In turbulence this is especially important when also a wing dropping may occur. Spin development from wing dropping strongly depends on the C. of G. position and also to some extent on the pilot reaction.

For C. of G. positions of up to 315 mm (12.4 in) aft of datum, the ASK 21 Mi does not spin at all. This configuration applies to two heavy pilots. For C. of G. positions from 320 mm through 385 mm aft of datum, more incipient spin turns are possible followed by self recovery after up to $4\frac{1}{2}$ turns at most. Such C. of G. positions can be reached in dual flight only with a lightweight pilot in the front seat.

For C. of G. positions of more than 400 mm (15.75 in) aft of datum controllable sustained spins are possible. Such C. of G. positions usually are only possible with one pilot flying solo.

Note: During spins the ASK 21 Mi oscillates in pitch. From a steep nose down spin recovery according to the standard procedure (see Section 3) is up to 1 turn, from a flat slow spin less than 1 turn.

The speed at which the stall takes place depends on the payload. The following standard values are applicable:

Flight mass	Stall Speed IAS	
	Airbrakes retracted	Airbrakes extended
Single 570 kg 1257 lb	72 km/h 39 kts 45 mph	75 km/h 41 kts 47 mph
Dual 705 kg 1554 lb	80 km/h 43 kts 50 mph	83 km/h 45 kts 52 mph

High Speed Flight:

The aircraft shows no flutter tendency within the permissible speed range. With airbrakes extended in a 45° dive the speed remains below $V_{NE} = 280$ km/h (151 kts, 174 mph); at all up weight of 705 kg speed will be up to 251 km/h (136 kts, 156 mph).

Joint Airworthiness Requirements imply the following important consequences:

Caution: Fly within the yellow range in calm air only (no strong turbulence).

Caution: When exceeding maneuvering speed (i.e. yellow range on the ASI) full control deflections must no more be applied. At V_{NE} (Red Radial Line) only one third of full control deflections are permissible any more.

Caution: Within the yellow range, airbrakes must only be extended under positive g-loads and only if the maximum load factor of 3.5g is not exceeded.

Caution: And generally the following applies: during strong gust loads do not use the full margin of control deflections. Simultaneous full gust loads and maneuvering loads can overload the structure.

4.5.5 Landing Approach and Landing

Preferably carried out with propeller retracted.

If the electric power supply fails, it is possible to land with the propeller extended. Ignition and Power-Plant Main Switch must be OFF, the fuel valve CLOSED and the propeller stop lever ENGAGED.

If the propeller is still extended, the increased sink speed should be borne in mind. It may be possible to do without use of the air brakes during the landing, and a firmer round-out and hold-off will be needed.

Note: Compared to the pure sailplane, the higher mass of the ASK 21 Mi requires a higher approach and touch down speed to achieve a neat round-out and hold-off without stalling.

The most favorable approach speed is about 98 km/h (53 kts, 61 mph). In case of turbulence it may be advisable to increase the approach speed slightly. Even steep approaches may be slowed down efficiently with the airbrakes.

Caution: The airbrakes increase the stalling speed by about 3 km/h (1.6 kts, 2 mph).

Side slipping is an additional suitable means to increase the sink rate in the approach. In the side slip with full rudder, the rudder pressure decreases to zero. To terminate the side slip, rudder must actively be pushed back.

As the ASI reads no useful values during side slipping, airspeed must be estimated from the pitch attitude.

4.5.6 High Altitude Flights

Flutter tests were carried out at about 2000 m (6500 ft msl). As the ASI under-reads at increasing altitude, but since flutter limits for light aircraft are determined by the true air speed, the following limitations apply to flights at greater altitudes:

V _{NE} speed limit for high altitude		V _{NE} speed limit for high altitude		
Altitude MSL [m]	V _{NE} IAS [km/h]	Altitude MSL [ft]	V _{NE} IAS [kts]	V _{NE} IAS [mph]
0 - 2000	280	0 - 6500	151	174
< 3000	267	< 8000	147	170
< 4000	255	< 12000	139	160
< 5000	239	< 16000	130	150
< 6000	226	< 20000	121	140

If these indicated air speeds are observed, the true air speed above 2000 m altitude msl. will remain constant at 309 km/h (167 kts, 192 mph). Therefore, in spite of a considerably lower airspeed reading, the actual speed achieved relative to the ground will be adequate for penetrating even against strong head winds at greater altitudes.

The placard for V_{NE} in high altitudes is affixed next to the ASI.

Warning: Avoid long flights at temperatures below -25°C (-13 °F) as the anti-freeze in the liquid coolant is only effective until such temperature.

Warning: Cold engine oil becomes so thick that the lubrication feed can fail.

When the engine had been running and is retracted, our experience is that it will cool down only slowly. This makes engine operation still possible after a short time in colder air.

Note: A too cold liquid coolant becomes thick and may obstruct the radiator. This leads in a very short time to increased engine operating temperature. The engine must then be switched off and the propeller [RBG2] must be retracted. The pilot must wait until the now warm power-plant components have warmed up the radiator.

Warning: Flights in icing conditions are not advised, especially when the aircraft got wet before climbing through icing level (0°-limit). Experience suggests, that drops of moisture on the surface will be blown back, lodge in the control surface gaps, and will dry there comparatively slowly.

This may cause the controls to become stiff, or in extreme cases, may jam them. On the other hand, a single climb through icing level (0°C) with a previously dry aircraft, is not likely to impair the use of the controls, even if heavy icing-up of wing and tail unit leading edges occurs.

4.5.7 Flight in Rain

Rain drops, frost and ice impair the aerodynamic qualities and also alter the flying behavior. Therefore the quoted minimum speeds for straight and circling flight should, in such conditions, be increased by some 10 km/h (5.5 kts, 6 mph). Airspeed then should not be allowed to drop below these values.

Rain drops must be removed from a wet aircraft before take-off.

Warning: A wet aircraft does **not** meet the performance data as stated in Section 5. This is valid particularly with respect to the take-off tables.

Do not fly into icing conditions with a wet aircraft. In this context, see also Section 4.5.6 above.

4.5.8 Cloud Flying

Required minimum equipment for cloud flying see Section 2.13.

According to previous experience the airspeed indicator system is not susceptible to icing-up. However with strong icing-up the pilot must always assume the risk of a possible failure of the airspeed indicator. When planning cloud flying, he must take this point into consideration.

Excessive speeds during cloud flying must be avoided in any case. The pilot should try to keep an average speed of about 100 km/h (54 kts, 62 mph). At increasing speeds above 130 km/h (70 kts, 81 mph) he should use the airbrakes to control the speed.

Warning: Cloud flying must only be done by pilots having the necessary licence. The legal regulations with regard to airspace and the requirements for instruments have to be met.

4.5.9 Aerobatics

The following aerobatic maneuvers are approved – however, only with the power-plant retracted.

With and without spin ballast at the fin:

SPIN

Only without spin ballast at the fin:

STEEP CLIMBING TURN

LAZY EIGHT

LOOP UPWARD

Contrary to the pure sailplane ASK 21, the powered version is type certified in the category *Utility*. Therefore, only a small number of aerobatic maneuvers are permissible. The pilot is advised to adhere strictly to this, as the permissible load factors are lower than for the ASK 21. Moreover, the engine oil will escape via the vent opening at negative load factors.

Never release stick and rudder pedals when flying aerobatics.

The trim remains in the center position for aerobatic maneuvers.

If the pilot loses control of the aircraft or if the speed increases involuntarily too rapidly, extending the airbrakes may indeed reduce the increase in speed, yet the margin for the pilot becomes more limited: With extended air brakes the permissible load factors are lower (see Section 2.9) and the loss in height is larger.

SPIN

The ASK 21 Mi enters spins reliably only with rear C.G. positions. In order to enable spin instruction with two pilots up there is the option to install a mount for trim plates at the fin (spin ballast). Further details on the spin ballast are given in Section 9.

Caution:

During spins the ASK 21 Mi oscillates in pitch. From a steep nose down spin recovery according to the standard procedure takes up to 1 turn (see Section 3.5), from a flat and slower spin less than 1 turn.

The altitude loss from the beginning of the recovery may be about 70 to 100 m (230 to 328 ft). With forward C.G. positions the spin may change into a spiral dive.

Recovery:

Spinning is terminated according to the standard procedure, see Section 3.5

Entrance of the spin:

The most favorable entrance speed is 2 km/h (1-2 kt, 1-2 mph) above the speed where stall warning commences. This must be ascertained in flight previously.

Apply full rudder deflection into the desired direction of the spin and subsequently full elevator deflection. The aileron remains neutral. Controls must be kept in this position for the whole of the spin.

Warning:

If the spin changes into a spiral dive, this must be terminated immediately, in order to avoid overstressing the structure.

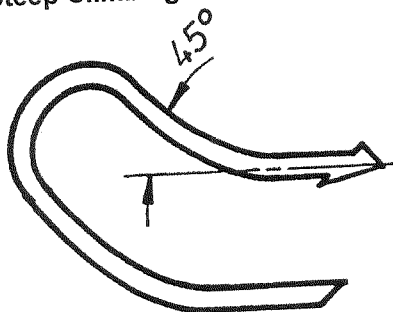
Steep Climbing Turn

Entrance speed:

single: 150 km/h, 81 kts, 93 mph
 dual: 160 km/h, 86 kts, 100 mph

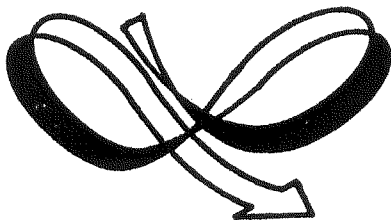
Lazy Eight

Entrance speed:

single: 150 km/h, 81 kts, 93 mph
 dual: 160 km/h, 86 kts, 100mph

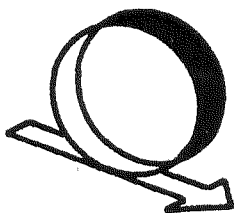
Loop upwards

Entrance speed:

single: 170 km/h, 92 kts, 106 mph
 dual: 180 km/h, 97 kts, 112 mph

max. acceleration: 2 – 3 g

Section 5

- 5. Performances
 - 5.1 Introduction
 - 5.2 Section approved by EASA
 - 5.2.1 ASI Indication Errors
 - 5.2.2 Stall Speeds
 - 5.2.3 Take-Off Performances
 - 5.2.4 Flight Performance with Engine Running
 - 5.3 Additional Information
 - 5.3.1 Demonstrated Cross Wind Components
 - 5.3.2 Flight Polars
 - 5.3.3 Noise Emission

5.1 Introduction

This Section contains EASA-approved data relating to ASI indication errors and stall speeds, as well as additional data and information which do not require approval.

The data in the charts and tables were established by means of test flights with a powered sailplane in good condition, and based on average pilot ability

5.2 EASA-Approved Data

5.2.1 ASI Indication Errors

ASI indication errors are negligible for the entire speed range up to 280 km/h (151 kts, 174 mph).

Note:

Both ASI must take their Pitot pressure from the Pitot tube in the fuselage nose, and static pressure from the static ports in the fuselage tail boom.

5.2.1.1 Diagram ASI Calibration

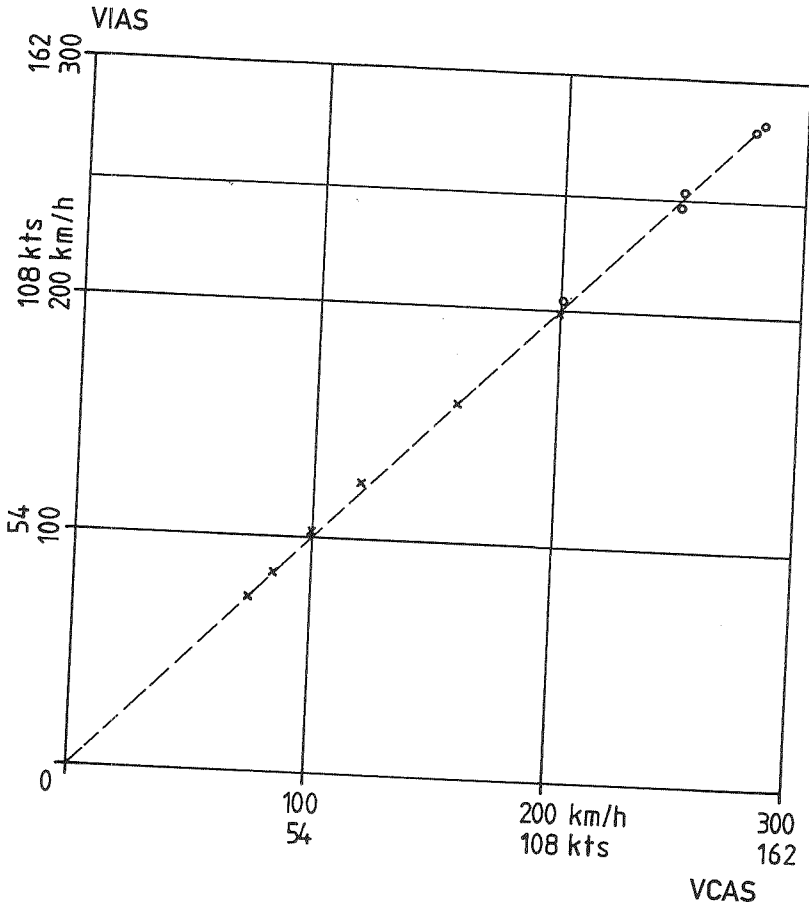

V_{IAS} = Indicated Air-Speed

V_{CAS} = Calibrated Air-Speed

5.2.2 Stall Speeds

The stall speed is depending on the payload. The following reference values are applicable (IAS, propeller retracted):

Flight mass	Stall Speed IAS	
	Airbrakes retracted	Airbrakes extended
625 kg 1378 lb	76 km/h 41 kts 47 mph	79 km/h 43 kts 49 mph
705 kg 1554 lb	80 km/h 43 kts 50 mph	83 km/h 44.8 kts 52 mph

Stall speeds with the power-plant removed:

Flight mass	Stall Speed IAS	
	Airbrakes retracted	Airbrakes extended
545 kg 1202 lb	71 km/h 38.3 kts 44 mph	73 km/h 39 kts 45 mph
625 kg 1378 lb	76 km/h 41 kts 47 mph	79 km/h 43 kts 49 mph

5.2.3 Take-Off Performances

The take-off performances given below are applicable to take-offs on hard and level grass runways and for the aircraft, propeller, and engine in good condition and for the following conditions:

Airfield elevation	0 m NN
Temperature:	15 °C
Air Pressure:	1013 hPa
Take-off mass (with two pilots):	705 kg
Speed (V _{IAS}):	100 km/h 54 kts 62 mph

	Grass runway	Hard runway
Take off roll:	270 m 886 ft	215 m 705 ft
Take-off distance to 15 m (50 ft) height:	515 m 1690 ft	460m 1509 ft

The influence of air temperature and air pressure (airfield elevation) on take-off performance is given in the take-off charts (see Section 5.2.3.1.)

Caution:

In rain (wet wings) or with frost or ice on the leading edges, the aerodynamic quality of the aircraft is drastically reduced. Take-off is prohibited! First, wing and tailplane must be cleaned!

Tailwind as well as an uphill runway increase the take-off distances considerably. The possibility of abandoning the take-off must be considered, see also Section 4.5.1, point (3) Self-Launch.

5.2.3.1 Take-off Charts

Caution: For other runway surface conditions such as wet grass, soft ground, high grass, snow and water spots etc., which are not given in these charts, it is recommended to use the additional distance factors or percentages given in the AIP (Airport) Manual Volume 1!

The following chart gives values for take off roll and take-off distance to 15 m (50 ft) height related to various airfield elevations and temperatures.

Take-off mass = 705 kg (1554 lb)

Altitude m	Temperature °C	On hard surface		On grass	
		Take-off roll m	Take-off distance m	Take-off roll m	Take-off distance m
0	-15	160	342	190	372
0	0	186	399	228	441
0	15	215	460	273	518
0	30	246	527	326	606
500	-15	188	402	228	442
500	0	219	468	274	524
500	15	252	539	330	617
500	30	288	617	395	723
1000	-15	221	472	274	525
1000	0	257	549	331	624
1000	15	296	633	400	737
1000	30	338	724	482	867
1500	-15	260	556	331	627
1500	0	302	646	402	746
1500	15	348	744	488	884
1500	30	397	850	592	1045
2000	-15	306	655	401	750
2000	0	355	760	491	896
2000	15	409	875	600	1066
2000	30	467	1000	734	1267

Altitude m	Temperature °C / °F	On hard surface		On grass	
		Take-off roll ft	Take-off distance ft	Take-off roll ft	Take-off distance ft
0	-15 °C / 5 °F	525	1123	624	1222
0	0 °C / 32 °F	611	1308	749	1446
0	15 °C / 59 °F	705	1509	896	1700
0	30 °C / 86 °F	808	1728	1068	1989
1500	-15 °C / 5 °F	608	1300	736	1428
1500	0 °C / 32 °F	707	1513	886	1692
1500	15 °C / 59 °F	816	1745	1064	1993
1500	30 °C / 86 °F	934	1998	1274	2338
3000	-15 °C / 5 °F	704	1507	870	1673
3000	0 °C / 32 °F	819	1752	1052	1986
3000	15 °C / 59 °F	944	2020	1268	2344
3000	30 °C / 86 °F	1080	2311	1526	2757
4500	-15 °C / 5 °F	817	1748	1033	1965
4500	0 °C / 32 °F	950	2032	1255	2337
4500	15 °C / 59 °F	1094	2341	1520	2767
4500	30 °C / 86 °F	1251	2677	1841	3267
6500	-15 °C / 5 °F	998	2134	1307	2444
6500	0 °C / 32 °F	1158	2478	1598	2918
6500	15 °C / 59 °F	1334	2854	1952	3472
6500	30 °C / 86 °F	1524	3261	2389	4126

5.2.4 Flight Performance with Engine Running

Climb Rate:

At MSL and normal atmosphere the ASK 21 Mi climbs at a rate of **2.25 m/s** (443 ft/min) at the best climb speed of $v_y = 100$ km/h (54 kts, 62 mph) (with take-off power).

Cruise:

Cruise speed is $v_H = 125$ km/h (67.5 kts, 77 mph) at 7100 RPM.

Range:

With full fuselage fuel tank the engine running time is about 85 minutes, if the climb is done in three saw tooth for three minutes at max. 7750 RPM and then continued at 7100 RPM. Climb speed is $v_y = 100$ km/h (54 kts, 62 mph). This corresponds to a flight distance of 140 km (75 Nm) and a theoretical height gain of about 6400 m (20997 ft). From this height glide at the best L/D gives another 210 km (113 Nm). The maximum range is then 350 km (188 Nm) under the following conditions:

Climb rate of **2.1 m/s** (413.4 ft/min) at 7750 RPM, mean flight height of 500 m (1640 ft), maximum take-off mass (weight) and standard temperature.

Climb rate of **1.4 m/s** (275.6 ft/min) at 7100 RPM, mean flight height of 1500 m (4921 ft), maximum take-off mass (weight) and standard temperature.

Fuel consumption of 17 l/h (4.49 US Gal/h) for take-off performance (3 min at 7750 RPM) and 16 l/h (4.23 US Gal/h) at 7100 RPM).

Any loss due to extending and retracting the propeller is not taken into account.

Type of fuel and aerodynamic condition of the aircraft can significantly affect this result. Therefore, this example should be used as guidance only.

If the cruise flight is done at $v_H = 125$ km/h (67.5 kts, 77 mph) and at 7100 RPM, a fuel consumption of 14 l/h (3.7 US Gal/h) gives a flight time of 98 minutes from a full fuselage tank. This provides a range of 200 km (108 Nm). A gain in altitude, which could be used for glide, is not obtained. Fuel to warm up the engine and for taxiing was not subtracted.

The current fuel consumption is indicated on page 3 of the ILEC-LC Display as „fuel flow“. See Section 7.9 of this Flight Manual for additional information.

5.3 Additional Information

5.3.1 Demonstrated Cross Wind Components

Self-launch:	15 km/h	8.1 kts
Winch Launch & Auto Launch:	20 km/h	10.8 kts
Aero tow:	20 km/h	10.8 kts
Landing:	20 km/h	10.8 kts

5.3.2 Flight Polars

The speed polar of the ASK 21 as pure sailplane was measured in comparison flights by the DFVLR-Idaflieg.

5.3.2-1 Flight Polars

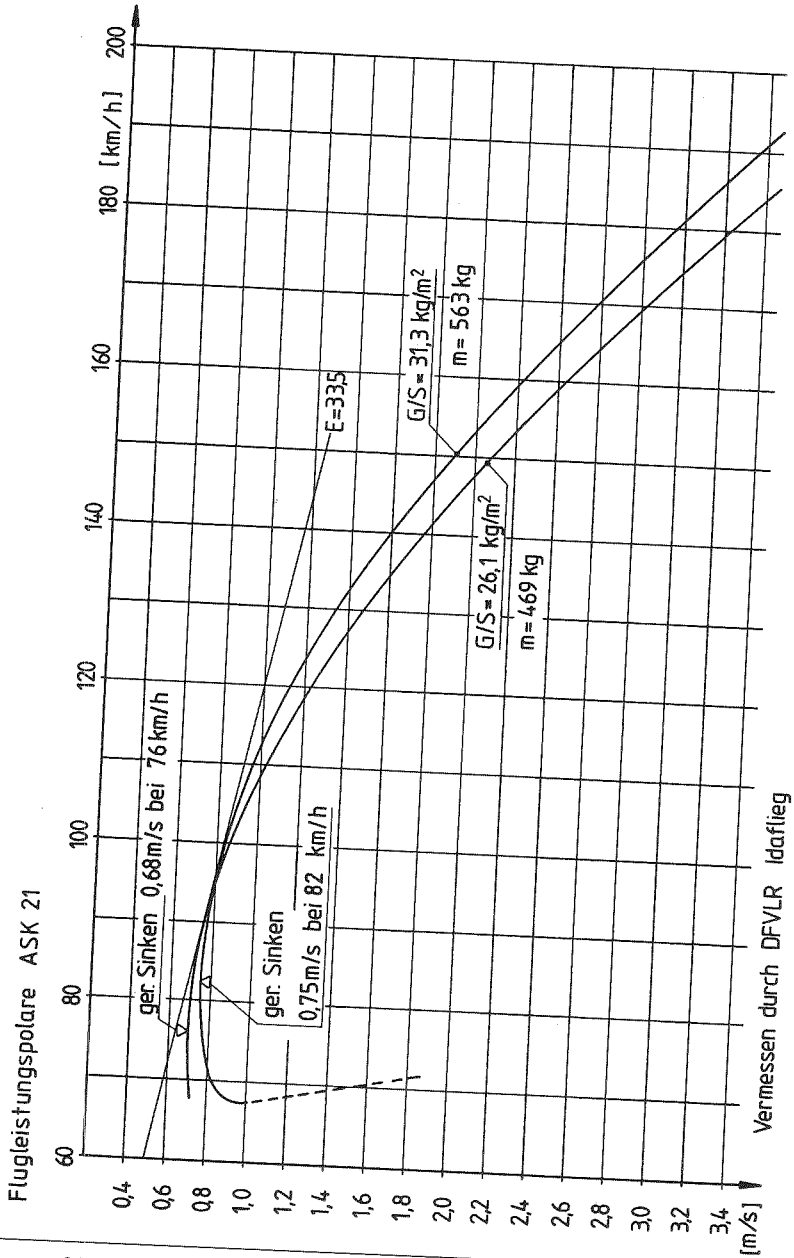

Issue: 01.12.2007 mh / mg / mm
 Revision:

5.3.3 Noise Emission

The noise emission measurements were carried out in accordance with ICAO, Annex 16, Volume I, Chapter 10 (corresponds the currently valid German requirements *Lärmschutzverordnung für Luftfahrzeuge [LVL]*, date Aug. 1, 2004, published in NfL II 70/04).

Measured Value: 66.5 dB(A)

Section 6

6. Mass (Weight) and Balance, C.G. Position

6.1 Introduction

6.2 Mass (Weight) and Balance Form

6.1 Introduction

This Section describes the limits of load distribution, inside which the ASK 21 Mi can be safely operated.

Weighing procedure and calculation of permissible C.G. limits are described in the **Maintenance Manual**, Section 6. A complete list of the equipment which is installed in the aircraft during the weighing, is contained in the aircraft records together with a detailed weighing report.

6.2 Mass (Weight) and Balance Form

The Mass and Balance Form on the next page shows the maximum and minimum cockpit loads for both seats, as well as the total permissible load.

These mass and balance data must be calculated in accordance with the currently valid weighing report. The data and diagrams needed for establishing these are to be found in the **Maintenance Manual**, Section 6.

This Mass and Balance Form is only valid for the individual aircraft with the serial number specified on the title page of this manual!

For solo flights the pilot must sit in the front seat.

If the pilot mass in the front seat is less than the minimum stated in the Mass and Balance Form, this can be rectified by means of trim ballast weights to be fitted next to the nose tow release hook. In addition the following applies with regard to the minimum payload in the front seat: one third of the weight of the rear pilot contributes to the payload in the front seat.

The data for the minimum and maximum cockpit loads in both seats are applicable with empty fuel tank including the non-usable fuel quantity. Due to the position of the fuel tank the minimum load in the front seat is increased by 1 kg (2.2 lb) pro 5 liter fuel (1.32 US.Gal.).

The baggage compartment load in the wing roots must not exceed 10 kg = 22 lb for each side (soft material).

Cockpit load includes pilot weights (including parachutes), baggage, fuel, and any equipment that was not included in the current weighing.

Date of weighing	Empty weight C.G. behind datum BP 1	Front seat load incl. parachute 2 min max		Rear seat load incl. parachute 2 min max		Total payload in kg max	3	Signature & stamp,

1) for US-registered sailplanes show inches, other countries may use imperial or metric units
 2) for US-registered sailplanes show lbs, other countries may use imperial or metric units
 3) Where applicable old spin ballast table removed* (tick off), see FM p. 9.A.4 and where applicable p. 9.B.11

Section 7

- 7. Description of the Powered Sailplane, its Systems and Equipment
 - 7.1 Introduction
 - 7.2 Flight Controls and Trim
 - 7.3 Air Brakes
 - 7.4 Landing Gear
 - 7.5 Cockpit, Canopies, Safety Harness and Instrument Panels
 - 7.6 Baggage Compartment
 - 7.7 Power-Plant
 - 7.8 Fuel and Oil Tank System
 - 7.9 Electrical System
 - 7.10 Pitot and Static Pressure System
 - 7.11 Miscellaneous Equipment (Removable Ballast, Oxygen, Emergency Location Transmitter)

7.1 Introduction

This Section contains a description of the powered sailplane, its systems and equipment with instructions for use. Details of various optional systems and equipment can furthermore be found in Section 9.

A detailed technical description and overall view drawings are contained in the Maintenance Manual.

The principal purpose of this Section is to describe the controls in the cockpit, their layout and labels.

7.2 Flight Controls and Trim

(1) Aileron and Elevator

Both these controls are operated by means of the control columns fitted at both seats. Next to both sticks the trim release levers are fitted; the radio transmit button is mounted in addition on the front seat stick.

(2) Rudder

The rudder pedals are adjustable to suit leg length.

(a) Front seat:

Pedal adjustment:
grey knob at
right of stick

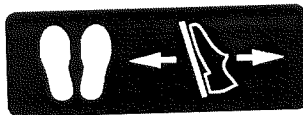

To move pedals aft:

Relax pressure on pedals and pull them back by the knob. Then release knob and apply pressure to pedals to lock in position.

To move pedals forward:

Pull knob and push pedals forward with your heels. Release knob and apply pressure shortly to pedals to lock in position.

(b) Rear seat:

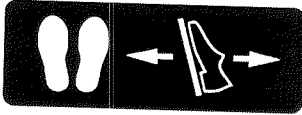

Pedal adjustment:

grey ring in front
of rear stick

To move pedals aft:

Relax foot pressure on pedals, lift grey ring to disengage from detent hole and pull pedals backwards by the ring. Re-engage the catch in the nearest detent hole to secure.

To move pedals forward:

Lift the grey ring to unlock, push pedals forward with your heels and re-engage the catch in nearest detent hole.

(3) Trim

The trim release levers are at the left side of the two control sticks. A trim indicator is fitted at the left cockpit wall at either seat.

Trim nose heavy



Trim tail heavy



7.3 Air Brakes

The air brakes are operated by either of the blue handles mounted at the left cockpit wall.

Pull the blue handle to extend the air brake paddles.

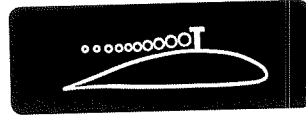

When the air brake handle is pulled back to its fullest extent, it will also actuate the hydraulic disc brake of the main wheel.

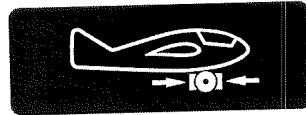

The air brakes extend on the upper wing surface only.

7.4 Landing Gear

The ASK 21 Mi uses a fixed, sprung main wheel, size 380 x 150.

The tail wheel size is 210 x 65, the nose wheel 4.00-4.

Optionally the ASK 21 Mi can be equipped with a steerable nose wheel, which is coupled with the rudder control circuit. In conjunction with the wing tip wheels which are also an available option, the ASK 21 Mi can roll on the ground on its own with the use of its power-plant.

Tire pressures:	main wheel	3.5 bar	(51 psi)
	tail wheel	2.5 bar	(36 psi)
	nose wheel	2.0 bar	(29 psi)

7.5 Cockpit, Canopies, Safety Harness, and Instrument Panels

Launch Cable / Towing Hook Release:

At the cockpit wall to the left of each instrument panel you will find the cable release ball handle (yellow).

Yellow cable release knob
for the towing hooks



Pulling either knob will open both tow release couplings. Both yellow release knobs are connected to each other.

To attach the launch cable, pull the yellow knob. Then just let it go to allow the tow release coupling to snap shut and lock. Do not guide the knob back to its original position by hand.

Seats and Seating Positions

Both seat pans use an adjustable back rest.

Tall pilots may remove the back rest. The choice of a thinner parachute pack of the new type will save further space.

Very short pilots will have to adjust their seating position by means of a firm stiff cushion so that all controls are within comfortable reach, and that they are prevented from sliding back during initial take-off acceleration (winch launch).

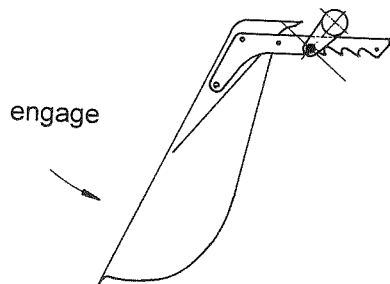
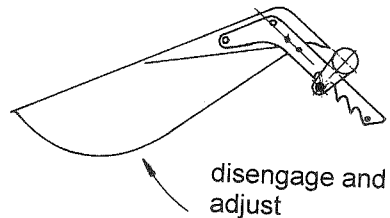

Adjustable head rest:

There is an adjustable head rest for the front seat. If the pilot uses the back rest, the head rest is inserted into the guide at the back rest. With the stop bolt the head rest is fixed at the correct height. Without back rest the head rest is inserted through the hole in the rear instrument panel cover. The ball catch must engage distinctly.

The head rest is correctly adjusted when the back of the head lies on the cushion at the level of the eyes.

Canopy Operation:

To open **front canopy**: pull the white lever handles mounted at either side of the canopy frame backwards. Canopy is hinged forward.

To lock front canopy: move white levers forwards.

The levers are marked by these adhesive labels:



To open **rear canopy**: pull the red lever handles mounted at either side of the canopy frame backwards. Canopy is hinged backwards.

To lock rear canopy: move red levers forwards.

The levers are marked by these adhesive labels:

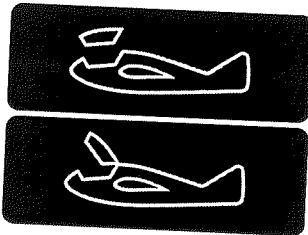

The rear red lever handles serve at the same time as emergency jettison levers (see Emergency Procedures in Section 3). Therefore, these levers are red and they are also marked with the pictogram for the canopy jettison.

Note:

If possible, do not leave the aircraft parked or unattended with canopies open, because

1. canopies could be slammed shut by a gust of wind which might shatter the Perspex;
2. at certain elevations of the sun they could act as concave mirror and thus they might destroy cockpit instruments and equipment.

Note:

An unlocked rear canopy could blow open during take-off and get damaged or destroyed respectively. To prevent this, a safety system has been incorporated which only allows the front canopy locking handles to be pushed home if the rear canopy is properly locked first.

If the front locking handles can only be pushed back about half-way towards the frame, this is an indication that the rear canopy has not been properly closed and locked. Do not try to force the front levers into the locked position, but lock the rear canopy first.

Safety harness:

The seat harness is anchored in such a way that it cannot jam the control runs underneath the seat pan.

Seat harness straps (including shoulder straps) must be worn at all times, and should be fully tightened. Check every time that each individual strap is properly secured in the harness lock. The lock should also be tested from time to time to ensure that it can be satisfactorily released under load.

Ventilation:

At the right cockpit wall below the canopy frame there are ventilation nozzles which are pivotable and adjustable. If correctly adjusted, they also serve as a demister for the canopies.



Instrument Panels:

For safety reasons, only GRP panels made in accordance with the factory lamination plan must be used.

Instruments weighing more than 1 daN (2.2 lbf) need further support, in addition to their fixing screws. This can be done by means of aluminum straps fixed either at the front canopy hinge, or to the rear instrument panel cowling.

Instruments with operating elements must be fitted where they are within easy reach also when the seat harness is worn.

Flight monitoring instruments, like ASI and altimeter, must be mounted within the pilot's field of view

7.6 Baggage Compartment

The area at the wing root rib leading edge can be used for baggage. The baggage compartment load must not exceed 10 kg (22 lb) for each side.

Baggage com-
partment **max. 10 kg**
22 lbs

7.7 Power-Plant

The Propeller of the power-plant unit - when retracted - is accommodated in the engine bay in the fuselage behind the wing. It is extended and retracted by means of an electric jack.

The following control elements are provided for the power-plant:

- **Control Console**
in the front cockpit: beneath the instrument panel
in the rear cockpit: in the instrument panel, at the left
- **ILEC engine control unit:**
installed in both instrument panels
- **ILEC Change Over Switch:** rod link at the left cockpit wall
- **Power-Plant Main Switch** (in the front instrument panel)
- **Fuel Valve** (right to the seat pan)
- **Switch for Fuel Pump 2** (in both instrument panels)
- **Rear-View Mirror** for propeller positioning (on the front instrument panel cover)
- **Fire Warning Light** (red flashing diode in the instrument panel)

Fig. 7.7-1 ILEC Power-Plant Control Unit, Overall View

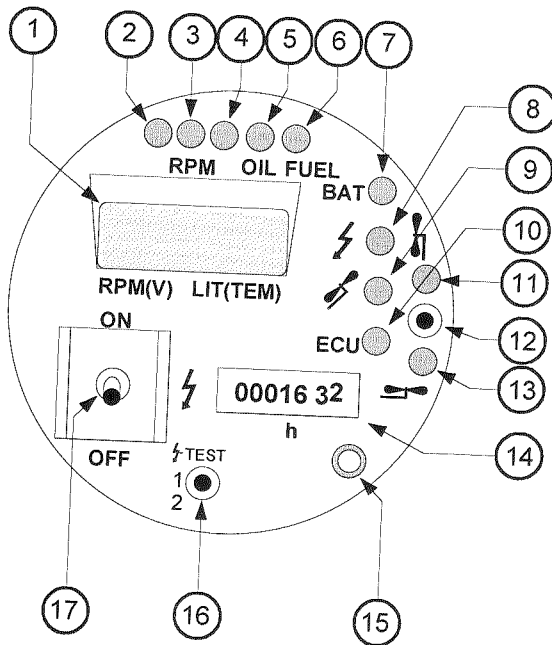

1. LC Display
2. **Green** LED for green RPM Range
3. **Yellow** LED for yellow RPM Range
4. **Red** LED for maximum RPM
5. **Yellow** LED: Engine Oil Warning
6. **Red** LED: Fuel Pressure Warning
7. **Red** LED: Generator Warning
8. **Red** LED: Ignition Off while attempting to start
9. **Red** LED: Propeller not fully extended
or power-plant in cooling position
10. **Red** LED: ECU error code
11. **Green** LED: Propeller fully extended
12. Switch for extending / retracting propeller
13. **Green** LED: Propeller fully retracted
14. Engine Hours Indicator (only for the front ILEC)
15. Shift LC Display button (push button)
16. Switch for testing ignition circuits
17. Ignition Switch

Description of ILEC Engine Control Unit:

The figures given in brackets refer to the numbering in the preceding ILEC Overall View.

Ignition [17]:

The ignition switch at the bottom left turns the ignition on and off. The switch is protected by a safety U-bracket against unintentional operation.

The switch signal "retract propeller" is led through the ignition switch via a separate pair of contacts, so that the propeller can only be retracted when the ignition is off.

With the ignition circuit test switch [16], which is located right hand below the ignition switch, the functioning of the ignition circuits 1 and 2 can be tested separately. Ignition circuit 2 is interrupted in switch position 1; vice versa ignition circuit 1 is interrupted in switch position 2.

Fuel pumps:

The fuel pump 1 is switched on at the same time as the ignition.

In addition, the second fuel pump can be activated by means of a switch in the instrument panel. However, it will only be on power when the ignition is on.

Switch for extending / retracting propeller [12]:

The extending/retracting switch located right hand moves the propeller tower. The switch engages in its "Propeller Extend" position; this means the propeller always extends fully, once the pilot has given the command. The switch has no detent-setting in direction "Propeller Retract"; so the electric jack stops immediately (the propeller stops retracting) when the pilot releases the switch

Note:

While the "Retract" switch is pressed the retraction process is automatically interrupted after 2/3 of the travel (cooling position). The pilot must press the switch again, if he wants the entire retraction at this point.

Limit switches fixed at the engine communicate to the micro controller once the end position "retracted" respectively "extended" is reached. The micro controller then switches off the electric jack.

The micro controller prohibits the retraction of the propeller unit as long as the ignition is on in order to prevent dangerous conditions. But the engine can be extended when the ignition is on, the starter however remains deactivated, until the propeller is fully extended. To indicate the actual position of the propeller unit to the pilot, two green LED's [11 and 13] have been positioned above and below the switch respectively. If the propeller is fully retracted, the lower LED [13] is permanent on. Whereas the upper LED [11] is permanent on, once the propeller is fully extended. At positions in between none of both LEDs is on, as the limit switch signals are missing.

Note: With ignition ON [17], the propeller can be extended, but not retracted.

RPM Measuring:

At about 1000 RPM the RPM indication shows up on the left side of the 8-digit LC-Display [1]. The RPM display has a resolution of 100 RPM and increases steadily up to 9900 RPM. At 7800 RPM the RPM-reading starts flashing.

To signal the approach to the permissible RPM limits, a green [2], a yellow [3] and a red LED [4] are installed above the RPM display. Each particular LED is permanently on, while the RPM is in the corresponding range. Reaching the yellow range, the green LED extinguishes and the yellow LED illuminates. Reaching the red range, the yellow LED extinguishes and the red LED lights up. The latter occurs parallel to the flashing of the RPM-reading.

The RPM ranges are:

Green	3000 to 7000 RPM
Yellow	7100 to 7700 RPM
Red	from 7800 RPM upwards

Fuel gauge of the Fuselage Tank:

The micro controller constantly measures the fuel content of the fuselage tank and shows it as 2-digit reading in liters on the right side of the LC-display [1]. If the fuel level in the fuselage tank falls below 3 liters (0.79 US. Gal), an alarm signal is audible to indicate the reserve amount of fuel. The alarm signal can be acknowledged by pressing the shift LC-display button [15], but automatically restarts after about 3 minutes.

Calibration of the fuel gauge:

With ignition off, retracted propeller and **topped up** fuselage tank press the "Retract" switch **[12]** (about 30 sec.) until the LC-display shows up a reading like this: **[102]**. Now the fuselage tank sensor is calibrated to the type of fuel in the tank. This calibration value is electronically stored. The calibration has to be repeated on each change of the type of fuel (e.g. from Mogas to Avgas).

Shifting through the pages of the LC-Display [1]:

Standard display (returns automatically after 5 seconds):

RPM Indication (4-digit) [RPM]	Fuel Quantity (2-digit) [Liter]
XXXX	XX

Range of indication: 0 to 23 liters (equivalent to 6 US.Gal) in steps of one liter. When falling below 3 liters (equivalent to 0.79 US.Gal) an alarm (horn) is set on.

Display after pressing the shift LC-display button **[15]**:

Press [15] once: (Page 1)	Liquid Coolant Temperature (3-digit) [°C]
H2O	XXX

Range of indication: 40°C to 120°C with a resolution of 2°C. Exceeding the limit temperature of 105°C, the display flashes and the alarm (horn) is set on.

Press [15] twice: (Page 2)	Internal Cooling Air Temperature (3-digit) [°C]
Air	XXX

Range of indication: 40°C to 128°C, with a resolution of 2°C.

Exceeding the limit temperature of 127°C the display flashes and the alarm (horn) is set on. **With ignition switched off this display is no longer available.**

Press [15] 3 times: (Page 3)	Current Fuel Consumption (4-digit) [Liter/h]
Fuel	XX.X

The measured data which the ECU (electronic engine control unit) provides, are indicated as current fuel consumption per hour.

Press [15] 4 times: (Page 4)	Engine Battery, Voltage (4-digit) [Volt]
U	XX.X

The three figures at the right side of the display **[1]** indicate the battery voltage with a resolution of 100 mV (e.g. 12.5).

The display returns to the main page, when button **[15]** has not been pressed for **about 5 seconds**.

If one of the temperature limits is exceeded, or the reserve fuel amount is too low, the alarm signal sets in. At the same time the measured value which has triggered the alarm, is shown on the LC-Display. By pressing the shift LC-display button **[15]**, the alarm signal can be cut off for the duration of about 3 minutes and the LC-Display **[1]** returns to the main page.

Operating hours:

The engine hours counter starts at a crankshaft revolution of more than 2000 RPM. The counter itself is a pure mechanical device.

The displayed data of the counter remain visible even without electric power. Therefore an intentional reset or manipulation of the counter is impossible.

Resolution 1/100 h, maximum indication 99 999.99 h.

Warning Signals:**Generator Voltage [7]:**

The warning light for the generator is located at the top right. When the propeller is extended this red light lights up, if:

- the RPM is less than 2000 RPM (regardless of aircraft system voltage)
- the aircraft system voltage falls below 12.8 V (at any RPM).

The reason may be a failure of the generator, or a high power consumption e.g. due to bad or flat batteries and simultaneous activation of the second fuel pump. Only for a short time the power supply can be covered by the batteries.

Warning:

Depending on the battery state of charge the pilot must assume the risk that the ignition and the injection unit fail and the engine stops running.

Ignition [8]:

1. Red flashing signal, if the starter button is pressed AND the ignition is **not** switched on. The starter is then blocked.
2. Red flashing signal, if the switch for the propeller retraction is pressed AND the ignition is switched on. Then the electric jack does not retract.

Propeller not extended or engine unit in cooling position [9]:

Red flashing signal, if the ignition is switched on AND the propeller is not extended. Then the starter is blocked.

In the cooling position of the engine unit (see Section 4.5.1(7)) the flashing LED reminds the pilot that the retraction process has not yet been finished.

ECU [10]: (Electronic Engine Control Unit)

This light serves to indicate an error when problems occur with a sensor or the ECU unit itself.

If there are no errors, the red light is on as soon as the Power-Plant Main Switch is pressed, i.e. the ILEC Control Unit is also switched on.

If the ignition is switched on, the LED remains on until the engine starts

to run. When the engine is running the light will be off if there are no errors.

A flashing of the ECU light indicates a problem in one of the following systems:

- | | | |
|------------------------------------|--------------------|---------------------------|
| • Map #1 Sensor | 1 1 | (Map =Manifold Pressure) |
| • Map # 2 sensor | 1 2 | |
| • Intake Air Temperature | 1 3 | |
| • Internal Cooling Air Temperature | 1 4 | |
| • Supply Voltage | 2 1 | |
| • Timing Sensor # 1 | 2 2 | |
| • Timing Sensor # 2 | 2 3 | |
| • Internal Electronic Errors | other combinations | refer to Engine Manual |

The red flashing signal of the LED can indicate the error code only with engine standing still but with ignition switched on again. The above listed error codes - each consists of two numbers - are counted out in flashes according to the respective failure of a sensor. If there is for example an error in the Intake Air Temperature sensor, the red ECU-LED goes on when the Power-Plant Main Switch is set and after the ILEC Control Unit has finished its start-up check. If the ignition is now switched on, the LED extinguishes and after about 10 seconds it will start with the error code. (E.g. the code for 1 3: The light will flash once and after a delay of one second will then flash three times). This error code is repeated once. If more than one sensor is damaged, then each code will be flashed in sequence with 5 seconds between codes.

Systems which are triggered by the core system of the engine control unit (ECU), for example injection valve and ignition coils, are not subjected to an error checking. That means a failure of these systems is not indicated by flashing of the red ECU-LED **[10]**.

For more detailed information refer to the Engine Manual.

Oil Supply [5]:

On the right next to the RPM-LED's the yellow engine oil supply LED is located. It is flashing, if the filling level in the lubricating oil reservoir falls below the minimum level. Then only a reserve of about 10 minutes is still available.

Warning: If the engine is operated beyond this time, the supply of lubricating oil ceases. The engine suffers non-repairable damage and will stop running after a short time.

A level sensor is installed in the reservoir. Its output signal triggers the warning light.

Fuel Pressure [6]:

At the right of the oil supply light the red fuel pressure warning light is located; the LED starts if the fuel pressure in the injection system drops and is insufficient to reach full engine performance. Reason may be a fault with the fuel pumps or the pressure regulator, else possibly a leak in the fuel system.

Warning: If this is the case, the engine must be shut off immediately. No self-launch is allowed.

If the defect occurs during take-off phase in powered flight, the necessary fuel pressure may possibly be reached by switching on the fuel pump 2. After reaching safety height the engine must be shut off immediately and the pilot must land without delay. The defect must be repaired prior to the next take-off.

Control Indicators [all]:

When switching on the ILEC Control Unit all LED's are lighted for about one second. At the same time all segments of all digits will appear in the LC-Display (88888888). Thus the proper function of all indicating elements can be checked.

Empty Page

Fig. 7.7-2 Power-Plant Control Console, front

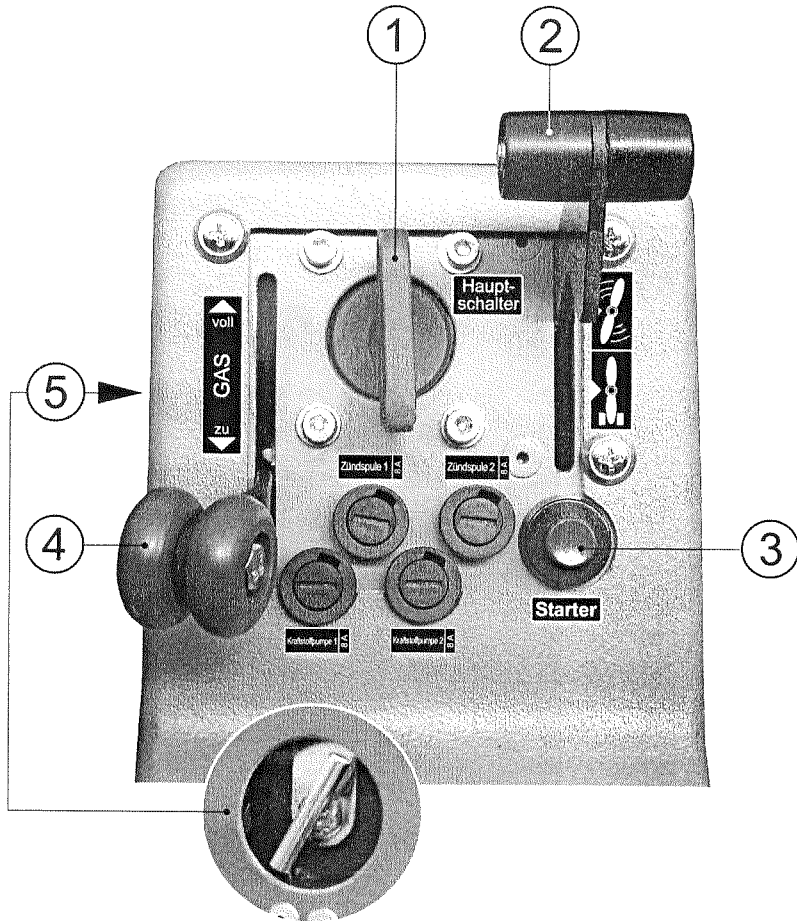

1. Main Switch for Power-Plant and Avionics (Engine Battery)
2. Propeller stop
3. Starter
4. Throttle
5. Adjusting twist knob for throttle friction brake

Fig. 7.7-3 Power-Plant Control Console, rear

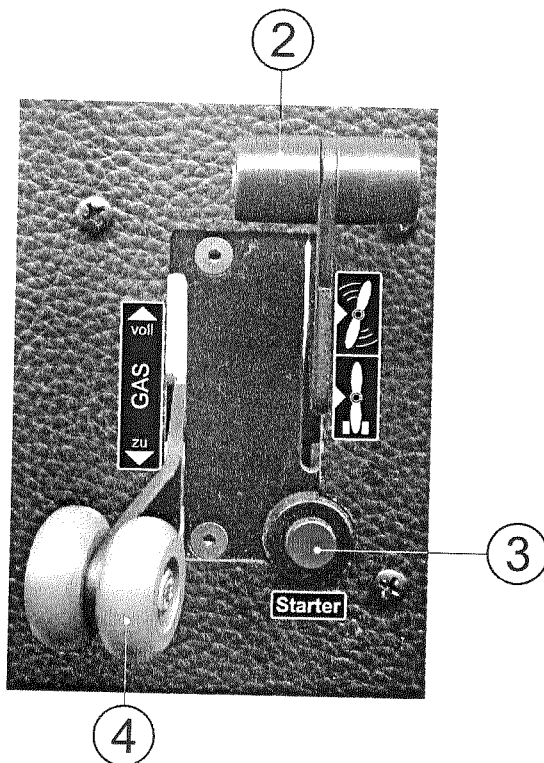

2. Propeller stop
3. Starter
4. Throttle

Description of the power-plant control console:

The figures in braces refer to the numbering in the preceding control console views.

The Power-Plant Main Switch {1} cuts out the battery from the power-plant and avionics circuit

When the propeller stop lever {2} is moved downwards, a stop block is pivoted into the arc of the propeller. A tab at the stop lever {2} obstructs the access to the "Starter" button {3}.

The Throttle {4} is set idle in the bottom position. The upper position is full throttle.

The throttle friction brake is adjusted with the adjusting twist knob {5} at the front control console. The throttle cable is spring-loaded (if a throttle cable breaks the throttle valve goes to full throttle). The friction brake in its normal setting prevents that the spring resilience draws the throttle to full position.

Further power plant controls in the cockpit:

Fuel valve:

The fuel valve is next to each seat pan at the right cockpit wall for both pilots.

In the forward position the fuel valve is open.
Rear position is shut.



Caution:

Prior to attempting to start the engine the position of the fuel valve must be checked and where necessary moved to its forward position.

Fire warning light:

A temperature sensor is fitted in the engine compartment, it triggers the fire warning at a temperature of 140 °C (284 °F). The fire warning is a red flashing LED in the upper area of the front instrument panel (it is also visible from the rear seat), and is marked with the following label

Fire

In case of a fire warning the pilot must proceed as per 3.8 in Section 3 "Emergency Procedures".

Rear view mirror for propeller setting:

This mirror is fitted on the front instrument panel cover at the right within the view of both pilots. By means of this mirror, the vertical position of the propeller must be checked prior to retracting it.

Switch for fuel pump 2:

As the fuel pumps are consuming relatively much current, to produce a fuel pressure of minimum 3 bar (43.5 psi), the engine start procedure should be carried out with only one active fuel pump. For this reason the fuel pump 2 is activated only temporarily by this switch during take-off until the safety height is reached.

The fuel pump 2 can be switched on from the front as well as from the rear seat, independent from the setting of the ILEC change-over switch. The pump is activated if both the ignition switch **and** the switch "Fuel Pump 2" are "ON" in at least one seat.

Note:

When the fuel pump 2 is constantly on, the charging current of the generator is just not sufficient to keep the battery voltage constant for a longer time. As a consequence the generator warning light at the ILEC control unit will go on; this may happen generally also if the battery voltage is too low. Especially prior to solo flights the pilot must satisfy himself that the switch of the fuel pump 2 in the rear instrument panel is „OFF“.

Change-over switch between both ILEC engine control units:

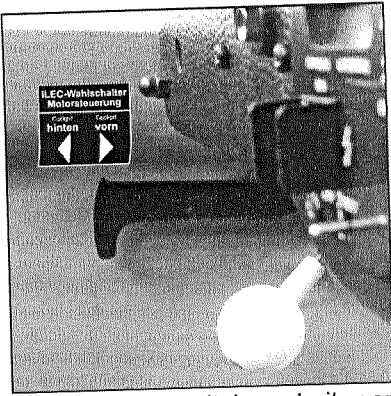

Change-over switch cockpit rear



Change-over switch cockpit front

In each cockpit one ILEC control unit is installed. The ILEC change-over switch selects the master unit.

Warning:

For the following reason it is prohibitive to switch over between the two ILEC control units during powered flight: If the ignition is set „OFF“ at the control unit to which the pilot wants to change, then the engine fails, as the ignition power supply switches off during change over.

Particularly for instruction flights we recommend generally that both pilots do all switching operations at the ILEC control unit synchronously (setting of the "Extend" / "Retract" switch and the ignition switch); this will prevent a different switch setting at the two units and thus exclude the above described situation.

7.8 Fuel and Oil Tank System

See also Fig.7.8-1 at the end of this Section.

The fuel tank is mounted in the fuselage above the spar passage with a fuel capacity for about 1 hour duration (at maximum continuous power).

The fuel drainer is located at the left-hand underside of the fuselage below the wing. The fuel tank vent is located next to the drainer.

The tank of the total loss oil lubrication is fitted in the engine compartment between engine block and exhaust silencer and is accessible when the propeller is extended.

Warning: The rotary engine uses total loss oil lubrication. If no oil is refilled into the oil tank or if the oil supply is interrupted, this will inevitably destroy the engine.

Avgas 100 LL or Super (car fuel grade)		Engine-Oil: 	
Fuselage Fuel Tank Capacity <small>ASK 21 Mi</small>		Silkolene Comp 2	
	23.2Ltrs	6.1 USGal	Pre-mix
non usable fuel	0.2Ltrs	0.05USGal	Castrol Aviation A545 or Bardahl KGR Injection Oil or Spectro Oils of America "Golden Spectro"
ATTENTION:		Top up with each refuelling !	
Check oil level in the oil tank!			

The oil consumption must be checked. The following reference values are given for this purpose (consumption depends on RPM):

- 0.21 liter oil/h (7.1 ounces/h) at revolutions of about 7100 RPM
- 0.23 liter oil/h (7.8 ounces/h) at revolutions of about 7750 RPM
- or slightly more than 0.015 liter (0.51 ounces) oil per 1 liter of fuel.

Refuelling the Fuselage Tank

The filling hole for the fuel is on the fuselage top to the left of the access hole cover. It is closed by a screw cap with an O-ring seal.

The filling hole is suitable for refuelling with a fuel nozzle. If refuelling is done from a petrol can, a funnel must be used.

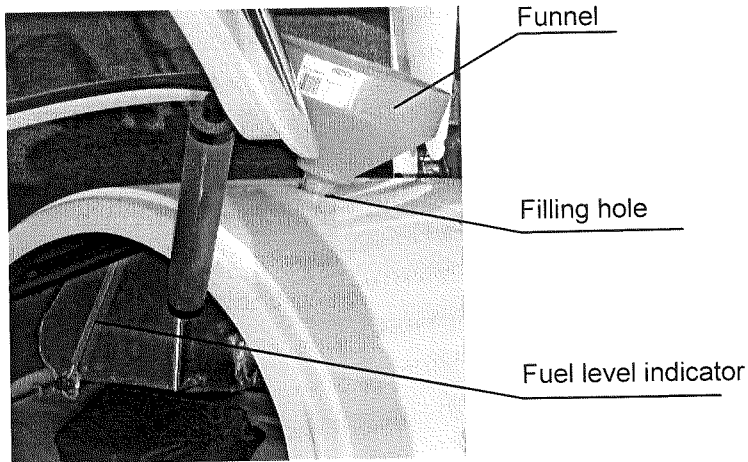

A fuel level indicator is at the front side of the tank. When filling the fuselage tank, the pilot can monitor here the fuel level. The maximum fuel level is indicated in order to avoid unintentional spilling the fuel.

Note:

The fuel level indicator at the front side of the tank can only indicate the upper tank capacity and thus serves merely as guidance for refuelling. The capacity indication next to the indicator tube is only valid with the aircraft resting on its tail and may also serve to recognize any gross wrong indication at the ILEC control units!

Note: If refuelling is done out of a can and it is not sure that there is no dirt nor water residues in the can, the fuel must be filtered by placing a piece of leather into the funnel.

7.9 Electrical System

Refer also to Fig.7.9-1 and 7.9-2 at the end of this Section.

(1) On-board Electric Circuit

The on-board electric circuit is normally also supplied by the engine batteries. As an additional power supply, one or several 12 Volt batteries can be fitted in the wing leading edge area behind the root rib. See also Fig.7.9-1.

Every electric consumer is protected with an own fuse. A fuse is also fitted closely to the batteries, which are mounted in the wing leading edge.

(2) Power-Plant Electric Circuit

An own independent electrical circuit supplies the power-plant. This is fused through the Power-Plant Main Switch. Refer also to Fig. 7.9-2.

The screw jack motor for extending and retracting the propeller is supplied from the engine batteries. These are fitted below the front pilot seat. During powered flight these batteries are charged.

It is depending on the state of charge of these batteries whether the propeller can be extended or retracted.

7.10 Pitot and Static Pressure Systems

Refer also to Fig.7.10-1 at the end of this Section.

The Pitot pressure for the ASI system is obtained from the Pitot tube in the fuselage nose, static pressure from the static ports at either side of the fuselage tail boom.

The aircraft comes as standard with a TE-probe in the fin (and the respective adaptor). During powered flight the pressure signals from this probe are unusable.

Ensure that the fin probe is fully pushed home in its seating. The inner end of the probe should from time to time be lightly lubricated with Vaseline or a similar lubricant, in order to save the O-ring gaskets from wear.

7.11 Miscellaneous Equipment

(1) Removable Trim Ballast as Compensation for Reduced Pilot Weight

As an optional extra the ASK 21 Mi can be equipped with trim ballast whereby the single lead trim plates are fixed about below the knees of the front pilot. In this location, for example a 3 kg (6.6 lb) lead trim plate has the effect of a pilot mass (weight) of 3.75 kg (8.27 lb) in the front seat.

(2) Oxygen

For reasons of space, due to the incorporation of the power-plant and the fuselage tank, only one oxygen bottle can be accommodated in the ASK 21 Mi, in the baggage compartment. The oxygen bottle fixtures are only supplied as optional extra and are not provided as standard equipment.

After fitting the oxygen bottle the pilot must make sure that it is securely seated and that the pin at the front mounting fixture is secured.

Note: Fitting of an oxygen system changes the empty mass (weight) C.G. position!

Warning: Fuel can ignite itself through pure oxygen.

(3) Emergency Location Transmitter

The least vulnerable location in case of accident is the area between the two drag spar pins at either side of the fuselage.

Therefore, the emergency location transmitter (ELT) should be fitted, in an appropriate mounting, in the compartment behind the spar tunnel (e.g. to the left fuselage wall. Control linkage elements and the access to or ventilation of electric components on the floor must in no case be impaired.

Depending on the model of the ELT further possible mounting positions are the fuselage wall above the opening to the wing leading edge baggage compartment, or - in an appropriate mounting - the cross tube at the rear instrument panel carrier.

Since the center fuselage section contains carbon fibre layers - and carbon screens the aerial radiation - the ELT aerial must be fixed in the canopy area. Yet the aerial must not be fitted direct to the canopy as it would be separated from the unit in case of a canopy jettisoning

Fig. 7.8-1 Fuel System

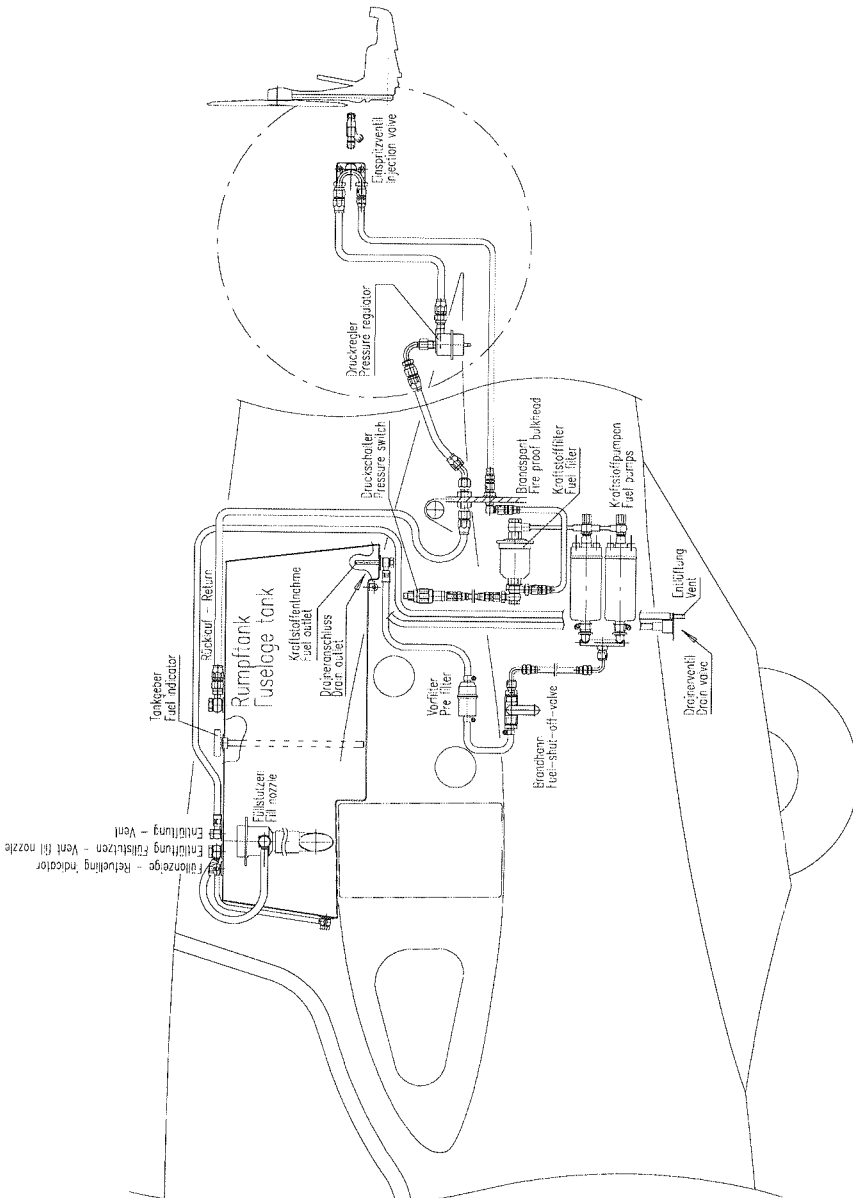

Fig. 7.9-1 On-Board Circuit

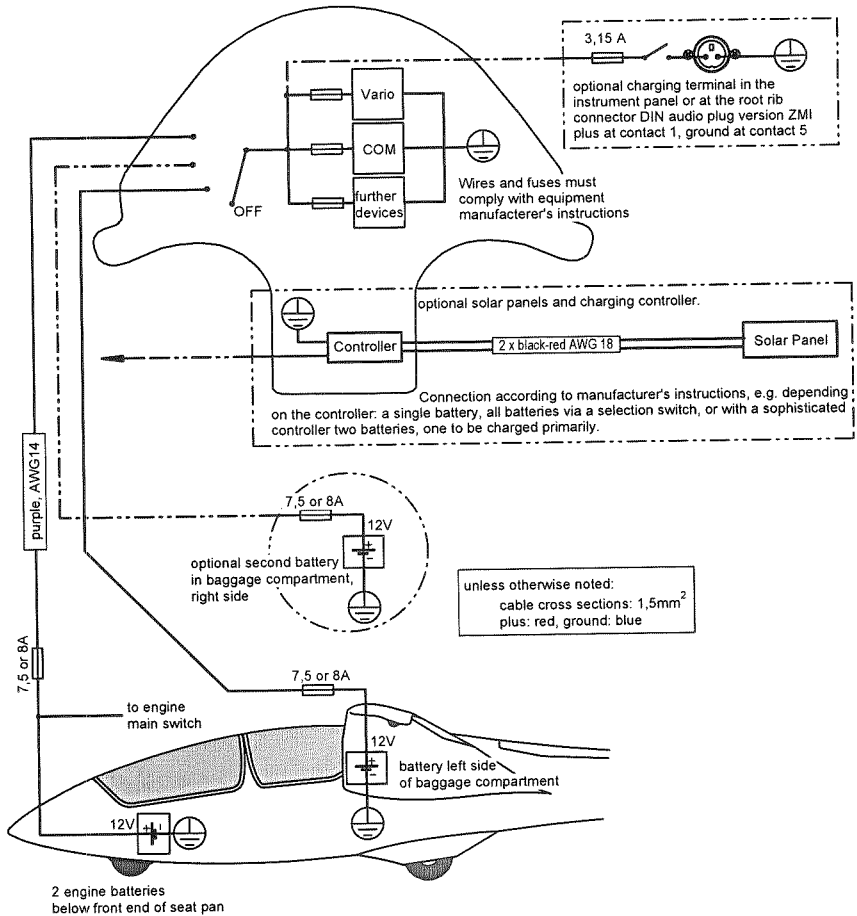
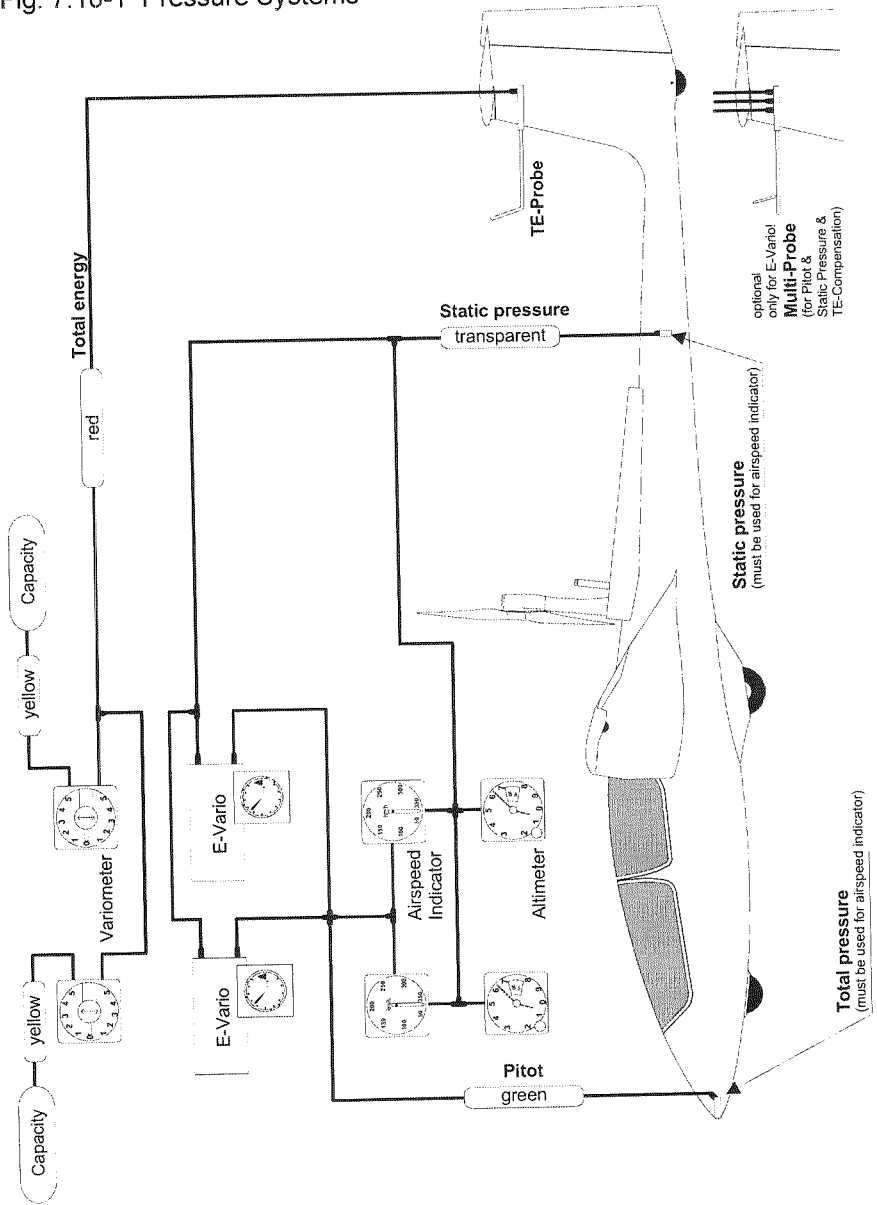

Fig. 7.10-1 Pressure Systems



Section 8

- 8. Handling, Care and Maintenance
 - 8.1 Introduction
 - 8.2 Powered Sailplane Inspection Periods
 - 8.3 Powered Sailplane Alterations or Repairs
 - 8.4 Ground Handling / Road Transport
 - 8.5 Cleaning and Care

8.1 Introduction

This Section contains manufacturer's recommended procedures for proper ground handling and servicing of the aircraft. It also identifies certain inspection and maintenance requirements, which must be followed if the aircraft is to retain that new-plane performance and dependability.

It is wise to follow a planned schedule of lubrication and preventive maintenance taking as a basis the climatic and flying conditions encountered.

8.2 Powered Sailplane Inspection Periods

A Certificate of Airworthiness renewal inspection must be carried out annually.

Further details can be found in the ASK 21 Mi Maintenance Manual, Sections 4 and 7, and in the separate Engine and Propeller Maintenance Manuals.

8.3 Powered Sailplane Alterations or Repairs

Regarding repairs and alterations, please see ASK 21 Mi Maintenance Manual, Sections 10 and 11.

It is important that the Aviation Authority concerned should be advised before carrying out any intended, but not officially approved alteration of the aircraft. This would ensure that the airworthiness of the aircraft is not compromised.

8.4 Ground Handling / Road Transport

(1) Parking

The ASK 21 Mi is equipped with plastic sealing tape at all control surface gaps. This means that when parking the aircraft principally all control surfaces must always be set to neutral!

In the open:

Parking of the aircraft in the open can be recommended only if foreseeable weather conditions remain suitable. It should be seriously considered whether the secure picketing, covering, and cleaning of the aircraft before the next flight may not demand more effort than de-rigging and re-rigging would have done.

For tying-down the wings: cradles (perhaps from the trailer) should be used which ensure that the ailerons cannot be stressed by the picketing ropes. There are tie-down holes in the wing tips.

Note: Parking in the open without protection against weather or light will reduce the life of the gel coat surface finish. Even after only a few weeks without intensive paint care, the polyester paint finish can become brittle and develop cracks.

Caution: The anti-freeze of the engine coolant liquid should be checked before the beginning of the cold season. If there is no sufficient anti-freeze in the coolant, the engine will be destroyed by deep temperatures!

In the hangar:

If the aircraft is parked in the hangar for protracted periods, it is recommended to cover only the Perspex canopy with a dust cover. On painted surfaces, dust covers may retain moisture from wet weather unnecessarily long. Moisture would impair the dimensional stability and even the strength of all fiber composite materials.

When parking, carefully remove any remainders of food (chocolate, sweets etc). Experience shows, that otherwise small animals could be attracted, and could cause damage in and to the aircraft.

(2) Road Transport

Messrs. Alexander Schleicher GmbH & Co. can supply dimensioned drawings of the ASK 21 Mi that will provide all the measurements needed for building a closed trailer. We can also supply the names and addresses of reputable trailer manufacturers.

Above all, it is important to ensure, that the wings are supported in properly shaped wing cradles or at the very least, that the spar ends are securely supported as close as possible to the root ribs.

Reinforced points of the fuselage are the main wheel (but watch the suspension springing!) and the tail wheel; also possibly the drag spar pins (make outer support bearings from plastic material like Nylon!), and under the fuselage the area under the canopy arch.

For an aircraft of this high quality and value, an open trailer, even with tarpaulin, cannot be recommended. Only a closed trailer of plastic or metal construction, or with heavy tarpaulin cover, may be considered suitable, which in any case should have light colored surfaces and be well ventilated while stationary to avoid high internal temperatures and high humidity.

Note:

The battery housings in the inner wing area are not designed to take up the transport loads if the wings are supported by the leading edge. With batteries installed, the housings may be damaged if the trailer runs on bumpy roads.

Caution:

During transport the elevator engaging actuator (on top of the fin) must in no case be loaded in any way (not even by soft foam blocks etc inside the trailer!). We think it is useful to have a lashing strap anchored in the trailer floor in order to secure the fuselage tail boom in front of the fuselage fin-transition.

In any case, be sure that the elevator engaging actuator is always free moving; even with the stick full back this must be guaranteed.

8.5 Cleaning and Care

Contrary to the false assumption, that plastic materials are impervious to moisture and ultra-violet light, we would state emphatically, that even modern fiber composite sailplanes **do** require care and maintenance!

(1) Moisture - effects on the fiber composite structure and on the gel coat

In the long run, moisture will also damage fiber composite structures because it penetrates into the epoxy resin base causing it to swell, which will partially burst even the tight cohesion of the plastic molecules.

In particular, a combination of high temperature and high humidity must be avoided (as e.g.: poorly ventilated trailer becoming damp inside which is then heated by the sun.)

Neither the best paint protection on the surfaces can fundamentally prevent water vapor diffusion; it can only retard the process. If water has entered the airframe and cannot be removed by means of sponge or chamois leather, the aircraft should be de-rigged and dried out, while periodically turning the affected part, in a room, which should be as dry as possible, but not too hot.

(2) Sunlight - effects on the gel coat surface finish

Sunlight - especially its UV component - embrittles the white polyester gel coat and the Perspex canopy. The wax layer on the gel coat will also oxidize and discolor more quickly if the aircraft is unnecessarily exposed to strong sunlight. There is no paint finish on the market yet which is unrestrictedly suitable for fiber composite sailplanes, and which would reach the life span of the fiber composite airframe structure without maintenance.

(3) Care of Gel coat Surface Finish

As a relatively durable wax layer protects the white polyester gel coat, it will tolerate being washed down from time to time with cold water, with a little mild cleaning agent added. In normal use, the wax coating need only be renewed once a year by means of a rotary mop (buffing wheel). In moderate European conditions, it will suffice if on two occasions a paint preservative is used in addition. In areas subject to long and stronger sun exposure it is required to do this more often.

For the care of the paint finish, only **silicone-free** products may be used, such as:

Einszett (1 Z) Special Cleaner-D 2
by Messrs. Werner Sauer GmbH & Co, 51429 Bergisch Gladbach,
www.einszett.com

or

Car Lack 68,
Car-Lack GFT + H mbH, 78464 Konstanz, www.carlack.de

Glue residues from self-adhesive tapes on the paint finish are best removed by means of benzine (petrol is toxic!) or paint thinners! After cleaning, renew the wax coating on these areas.

Note: For the signal and decorative paintwork we use cellulose or acrylic paint; therefore, no thinners must be used here and even benzine should not be allowed to act on them for prolonged periods.

(4) Canopies

The Acrylic Canopy (Plexiglass or Perspex) should only be cleaned by means of a special cleaner (e.g. „Plexus“ Plastic Cleaner or Chem-Tools „Acryshield“) or with lots of clean water. On no account should a dry cloth etc be used for dusting or cleaning. Likewise alcohol-containing cleaning agents must not be used.

(5) Safety Harness

The safety harness straps should be regularly inspected for tears, mould stain, and wear. Metal parts and buckles must be checked for wear or corrosion. The reliable operation of the release mechanism - even under simulated load - must be tested occasionally.

(6) Oil-Film and residual Oil Spots

From the exhausts of the running power-plant, a film of (partly burnt) oil residues develops on the tail surfaces. Prior to the normal cleaning of the paint surface this film should be wiped off with a soft and absorbent cloth. Power plant and engine compartment are cleaned in the same way where accessible.

(7) Fire Protection Coating of the Engine Compartment

The engine compartment is painted with a special fire protection paint, which is covered by a protective paint layer. The fire protection paint will develop a foam layer under heat, which in turn should reduce the heat conductivity into the structure.

The fire protection paint must be renewed when foam blisters have developed after strong heat.

For refreshing the paint see -> the **Maintenance Manual**.

Section 9

9. Supplements

9.1 Introduction

9.2 List of inserted Supplements

Supplements Inserted

9.1 Introduction

This Section contains appropriate supplements necessary to safely and efficiently operate the aircraft when equipped with various optional systems and equipment, which do not come as standard.

The following optional equipment has already been described in Section 7.11 of this manual:

- Removable Trim Ballast as Compensation for Reduced Pilot Weight
- Oxygen System
- Emergency Location Transmitter

9.2 List of Inserted Supplements

Date of Insertion	Document No.	Number Pages	Title of the inserted supplement
1. Dez. 07	A	4	Spin ballast
1. Dez. 07	B	12	Operation with removed engine

A - Spin Ballast

1 General

The powered sailplane ASK 21 Mi enters a spin only with in flight C.G. positions of $r = 400$ mm (15.75 in) and more. This supplement describes the use of spin ballast in order to practise spins with two pilots.

Thus the ASK 21 Mi can be used for spin instruction to come up against the fact that uncontrollable flight attitudes (wing dropping, spin &c) account for a great part of the serious accidents.

2 Limitations

The installation of spin ballast does not change the limitations of the ASK 21 Mi, this applies particularly to the C.G. range. A spin ballast table which is calculated individually for each serial number, is just for the purpose to adjust a C.G. position which otherwise would only be possible with one pilot on board.

The spin with spin ballast attached is principally only permissible with two pilots up. When spin ballast is attached, aerobatics are prohibited (except spinning).

A red placard is affixed in the cockpit within the pilot's view:

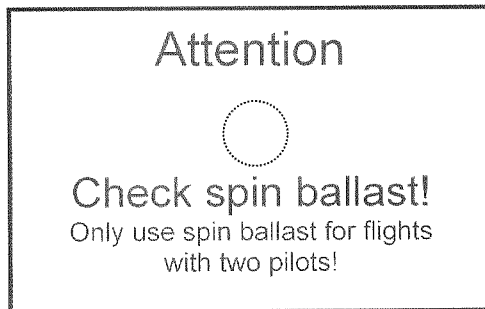

An M8-screw must be mounted through the placard from the backside of the instrument table. When the spin ballast is removed, the placard must be covered using the nut and washer that otherwise hold the spin ballast.

It must be done such that the nut and washer cover the text of the above placard.

3 Emergency Procedures

No changes become necessary for the emergency procedures.

4 Normal Procedures

During each pre-flight check it is necessary to verify that no spin ballast or only the intended spin ballast is attached.

Pre Take-off Check:

1. Tail dolly removed ?
2. Parachute fastened correctly ?
3. Automatic parachute rip-chord connected?
4. Safety harness tight (particularly lap belt) ?
5. Controls easy to operate ?
6. Airbrakes retracted and locked ?
7. Trim set in take-off position ?
8. Spin Ballast - Placard ?
9. Altimeter adjusted ?
10. Radio operational and transmission tested ?
11. Check wind direction !
12. Both canopies closed and locked ?
13. Action for aborted take-off in mind ?

Before every flight with spin ballast the pilots must be weighed with the equipment worn in flight (clothes, parachute ...). The amount of spin ballast is specified in the effective spin ballast-table (see Page "Spin Ballast" – 9.A.4). The mass of the pilot in the front seat defines the respective line of the table; the mass of the pilot in the rear seat defines the respective column. At the intersection, the number of ballast plates (each 1 kg = 2.2 lbs), which are to be attached, is noted.

All other ballast in the cockpit must be removed. When complying with the table a permissible in flight C.G. position is reached even if the minimum cockpit load goes below the value stated in the Mass and Balance Form.

Up to a maximum of 12 spin ballast plates are permissible. The plates have to be distributed evenly to the left and right side of the fin and must be fixed with the provided screw.

Caution: The washer and nut screwed on the cockpit placard (see above) **must** be used. After removal of the spin ballast the washer and the nut must be fixed again on the placard.

Spin, entrance:

As specified in Section 4.5.9.

Spin, recovery:

According to the standard procedure, as specified in Section 3.5.

5 Performance

The aerodynamic drag caused by the spin ballast plates impairs the glide performance of the ASK 21 Mi slightly.

Performance in powered flight will not change significantly.

Because of the aft C.G. position the aircraft naturally will respond more strongly to elevator deflections.

6 Weight and Balance

With every new weighing of the aircraft, an updated spin ballast-table must be requested from the manufacturer, and filed after this page. (Page 9.A.4 Spin Ballast, Details see Section 13.A in the Maintenance Manual).

The inspector must remove the old table after filling in the Mass and Balance Form in Section 6. Having requested and received the new table the owner / operator may insert this page himself without the necessity of an inspector.

Instead of this page the spin ballast table
can be inserted if applicable.

B – Operation with removed engine

1 General

When the engine has been removed, the ASK 21 Mi can be operated in the same way as the basic sailplane model ASK 21. This enables aerobatics also with negative maneuvers, yet requires on the other hand complying with all the limitations which are valid for the pure sailplane.

Because of the trim lead (fixed installation in the powered sailplane) the cockpit load of the pure sailplane cannot be reached (for weight and C.G. reasons).

The "Spin Ballast Table" 9.A.4 is no longer valid. When required, a new Spin Ballast Table can be requested from the manufacturer. But probably the range of cockpit load, for which the spin ballast suffices, is very restricted due to the fixed trim lead.

How to remove the engine: see Maintenance Manual Section 2.11.4 and 2.11.5, likewise the supplement Section 13.B in the Maintenance Manual.

Type Certification basis of the pure sailplane ASK 21 are the Airworthiness Requirements for Sailplanes and Powered Sailplanes (LFSM), issue 23.10.1975, with the Airworthiness Category 'A' (Acrobatic).

2 Limitations

The following values change:

2.6 Mass (Weight)

Maximum take-off mass:	600 kg	(1320 lb)
Max. mass of all non-lifting parts:	410 kg	(904 lb)

2.8 Approved Maneuvers

Loop upwards
 Stall Turn
 Split 'S'
 Half Loop and Half Roll
 Slow Roll
 Half Loop, Half Roll, and Inverted Flight
 Steep Climbing Turn and Lazy Eight
 Chandelle

2.9 Maneuvering load factors

max. positive load factor	+ 6.5
max. negative load factor	- 4.0
at an air speed of 180 km/h (97 kts, 112 mph)	

At increasing air speeds, these values will be reduced depending on the airbrakes setting to:

	retracted	extended
max. positive load factor	+ 5.3	+ 3.5
max. negative load factor	- 3.0	- 0
at an air speed of 280 km/h (151 kts, 174 mph).		

2.13 Minimum Equipment

In addition to the Minimum Equipment as already mentioned in Section 2 of the Flight Manual:

Parachute for each pilot

- 1 G-meter in the front instrument panel, it must have the following markings (only for operation with the mass limits of the "engine removed" version):

Marking	Value or range	Significance
Yellow Arc	+5.3 ~ +6.5 -3.0 - -4.0	Caution Range
Red Line	6.5 -4.0	Must not be exceeded

2.15 Operating Limitations Placard

The following placards replace the respective placards of the powered sailplane:

Segelflugzeugbau Alexander Schleicher GmbH & Co. Poppenhausen		Serial-No.: 21	
Model: ASK 21 Mi, with engine removed			
DATA an LOADING PLACARD			
Empty Mass (Weight):	<input type="text"/> lbs	<input type="text"/> kg	Maximum Permissible Speeds Calm Air: <input type="text"/> 151 kts 280 km/h Manoeuvring Speed: <input type="text"/> 97 kts 180 km/h Winch and Autotow Launch: <input type="text"/> 81 kts 150 km/h Aerotow A/T: <input type="text"/> 97 kts 180 km/h
Max. Mass (Weight):	1320 lbs	600 kg	
Min. Front Seat Load Solo:	<input type="text"/> lbs	<input type="text"/> kg	
Max. Front Seat Load:	<input type="text"/> lbs	<input type="text"/> kg	
Max. Rear Seat Load:	<input type="text"/> lbs	<input type="text"/> kg	Weak Link Winch Launch: <input type="text"/> 900 to 1100 daN (black) Aerotow: <input type="text"/> max 900 daN (brown)
Max. Total Combined Seat Load	<input type="text"/> lbs	<input type="text"/> kg	
Tire Pressure	Main Wheel:	<input type="text"/> 3,4 to 3,6 bar	Permissible Load factor only with engine removed positive: <input type="text"/> 6,5 g negative: <input type="text"/> -4,0 g
	Nose Wheel:	<input type="text"/> 1,9 to 2,1 bar	
	Tail Wheel:	<input type="text"/> 2,4 to 2,6 bar	

Approved Manoeuvres
In condition with engine removed according to Flight Manual 9.B!
<u>Only without Spin Ballast</u> Loop upwards, Stall turn Half loop and half roll, Chandelle, Split 'S', Steep climbing turn, Slow roll
<u>With and without Spin Ballast</u> Spin

3 Emergency Procedures

There are no changes for the emergency procedures.

4 Normal Procedures

4.5.9 Aerobatics

Even a sailplane approved for full aerobatics does not have infinite strength reserves. Most hazardous are aerobatics that are badly executed and get out of control, and so result in high loads.

Note:

The normal airspeed indicator system shows a large pressure error in inverted flight underreading by up to 40 km/h (22 kts, 25 mph). When extending the Pitot head by attaching a brass tube – Ø12x1; 140 mm (5.5 in) in length – this error disappears. The tube must stick out forwards by at least 70 mm (2.75 in). For normal flights this is not necessary. In order to avoid damage when parking the sailplane in the hangar, this tube should not be left mounted longer than necessary.

Inverted Flight Speeds	Without Pitot extension	With Pitot extension
Stall Speed, single	65 km/h 35 kts 41 mph	76 km/h 41 kts 47 mph
Stall Speed, dual	70 km/h 37.8 kts 43 mph	87 km/h 47 kts 54 mph
IAS Maneuvering Speed V_A	140 km/h 75.5 kts 87 mph	180 km/h 97 kts 112 mph
IAS Maximum Speed V_{NE}	240 km/h 130 kts 149 mph	280 km/h 151 kts 174 mph

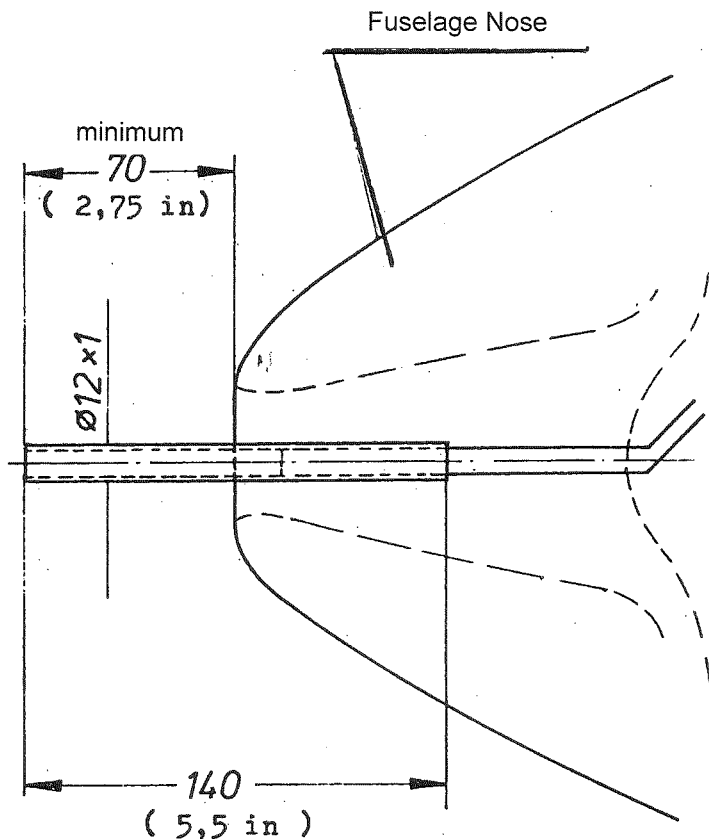

Extension tube for Pitot pressure head - for use during inverted flight.

Brass tube $\varnothing 12 \times 1$, 140 mm (5.5 in) in length.

A suitable plastic tube may also be used provided it is sufficiently stiff and straight.

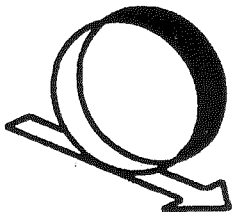
Loop upwards

Entry Speed:

single: 155 km/h, 84 kts, 96 mph
dual: 170 km/h, 92 kts, 106 mph

max. acceleration: 2 – 3g

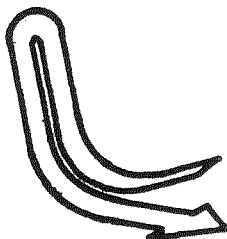
Stall Turn

Entry Speed:

single: 165 km/h, 89 kts, 103 mph
dual: 180 km/h, 97 kts, 112 mph

max. acceleration: 3g

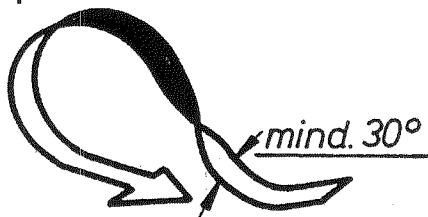
Split 'S'

Entry Speed:

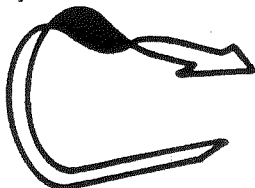
single: 170 km/h, 92 kts, 106 mph
dual: 180 km/h, 97 kts, 112 mphPull-up at least 30°!
Height loss approx. 100m
max. acceleration: 2 – 3g**Half Loop and Half Roll**

Entry Speed:

single: 165 km/h, 89 kts, 103 mph
dual: 180 km/h, 97 kts, 112 mph

max. acceleration: 2.5 – 3.5g

Slow Roll

Entry Speed:

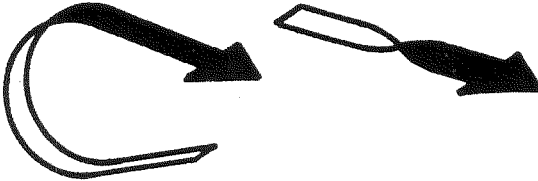
single: 150 km/h, 81 kts,
93 mphdual: 165 km/h, 89 kts,
103 mph**Half Loop, Half Roll, Inverted Flight**Note: during inverted
flight the fuselage nose
will be unexpectedly
high above the horizon.**Spin**

See Section 4.5.9

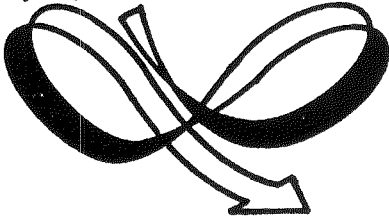
Lazy Eight

Entry Speed:

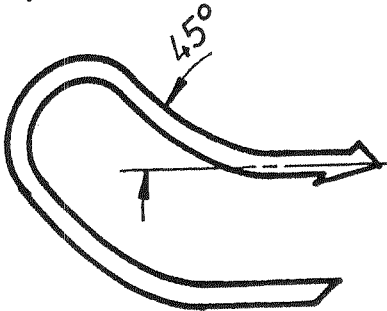
single: 140 km/h, 76 kts, 87 mph
dual: 150 km/h, 81 kts, 93 mph**Steep Climbing Turn**

Entry Speed:

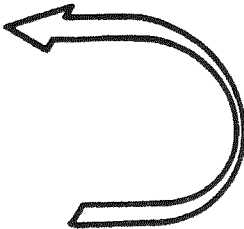
single: 140 km/h, 76 kts, 87 mph
dual: 150 km/h, 81 kts, 93 mph**Chandelle**

Entry Speed:

single: 160 km/h, 86 kts, 100 mph
dual: 175 km/h, 95 kts, 109 mph

On aerobatics instruction flights it must be reliably agreed between instructor and student how to communicate when taking over the controls.

Apart from that refer to Section 4.5.9.

Instead of this page the spin ballast table
can be inserted if applicable.